

TOSHIBA

1600EP SERIES

INSTRUCTION MANUAL

UNINTERRUPTIBLE POWER SYSTEM (UPS)
SINGLE PHASE - 3.6/6/8/10/14/18/22 kVA

January 2007
Part # 55288-001

Manufactured in the USA



The Toshiba products listed in this document are intended for usage in general electronics applications (computer, personal equipment, office equipment, measuring equipment, industrial robotics, domestic appliances, etc.). These Toshiba products are neither intended nor warranted for usage in equipment that requires extraordinarily high quality and/or reliability or where a malfunction or failure may cause loss of human life or bodily injury (“Unintended Usage”). Unintended Usage include atomic energy control instruments, airplane or spaceship instruments, transportation instruments, traffic signal instruments, combustion control instruments, medical instruments, all types of safety devices, etc.. Unintended Usage of Toshiba products listed in this document shall be made at the customer’s own risk.

NOTICE

PLEASE INFORM TOSHIBA INTERNATIONAL CORPORATION OR AUTHORIZED REPRESENTATIVE IN CASE OF INCONSISTENCIES, OMISSIONS, OR QUESTIONS.

The instructions contained in this manual are not intended to cover all of the details or variations in equipment, or to provide for every possible contingency concerning installation, operation, or maintenance. Should further information be required or if problems arise which are not covered sufficiently, contact your Toshiba sales office.

The contents of this instruction manual shall not become a part of or modify any prior or existing agreement, commitment, or relationship. The sales contract contains the entire obligation of Toshiba International Corporation’s UPS Division. The warranty contained in the contract between the parties is the sole warranty of Toshiba International Corporation’s UPS Division and any statements contained herein DO NOT create new warranties or modify the existing warranty.

Any electrical or mechanical modifications to this equipment without prior written consent of Toshiba International Corporation will void all warranties and may void the UL/CUL listing. Unauthorized modifications can also result in personal injury, death, or destruction of the equipment.

QUALIFIED PERSONNEL ONLY

Qualified Personnel are those that have the skills and knowledge relating to the construction, installation, operation, and maintenance of the electrical equipment and has received safety training on the hazards involved (Refer to the latest edition of NFPA 70E for additional safety requirements).

UNINTERRUPTIBLE POWER SYSTEM (UPS)

Please complete the following information and retain for your records.

Unless otherwise specified, the warranty period for the UPS or UPS part is 36 months from the shipment date (see Toshiba International Corporation bill of lading).

Unless otherwise specified, the warranty period for a UPS battery is 24 months from the shipment date (see Toshiba International Corporation bill of lading).

JOB NUMBER	_____
MODEL NUMBER	_____
SERIAL NUMBER	_____
APPLICATION	_____
SHIPMENT DATE	_____
INSTALLATION DATE	_____
INSPECTED BY	_____

Purpose

This manual provides information on how to safely install your Toshiba International Corporation power electronics product. This manual includes a section of general safety instructions that describes the warning labels and symbols that are used throughout the manual. Read the manual completely before installing, operating, or performing maintenance on this equipment.

This manual and the accompanying drawings should be considered a permanent part of the equipment and should be readily available for reference and review. Dimensions shown in the manual are in metric and/or the English customary equivalent.

Toshiba International Corporation reserves the right, without prior notice, to update information, make product changes, or discontinue any product or service identified in this publication.

Toshiba is a registered trademark of the Toshiba Corporation. All other product or trade references appearing in this manual are registered trademarks of their respective owners.

Toshiba International Corporation shall not be liable for direct, indirect, special, or consequential damages resulting from the use of the information contained within this manual.

This manual is copyrighted. No part of this manual may be photocopied or reproduced in any form without the prior written consent of Toshiba International Corporation.

© Copyright 2007 Toshiba International Corporation
All rights reserved.
Printed in the U.S.A.

Toshiba's Customer Support Center

Contact the Toshiba Customer Support Center for assistance with application information or for any problems that you may experience with your Uninterruptible Power System (UPS).

Toshiba Customer Support Center

8 a.m. to 5 p.m. (CST) - Monday through Friday
USA Toll Free (800) 231-1412
Tel (713) 466-0277
Fax (713) 466-8773

You may also contact Toshiba by writing to:

Toshiba International Corporation

13131 West Little York Road
Houston, Texas 77041-9990
Attn: UPS Product Manager

For further information on Toshiba's products and services, please visit our website at:

www.toshiba.com/ind

Table of Contents

General Safety Instructions	8
Symbols.....	8
Signal Words	9
IMPORTANT SAFETY INSTRUCTIONS	10
QUALIFIED PERSONNEL ONLY	10
Product Description	12
Application and Use.....	12
Output Rating.....	12
Power Backup.....	12
Power Conditioning.....	12
Inspection/Storage/Disposal	13
Inspection	13
Storage	13
Disposal	13
Installation Precautions	14
Operating Precautions	15
UPS Connections	16
Communication Interfaces	17
UPS Stop Signal Operation	18
RS-232C	19
RemotEye Network Card.....	19
UPS Specifications	20
Operating the UPS	26
Battery Backup Time and Discharge Process	26
Starting the UPS.....	27
Battery Recharging.....	28
Online Mode	29
AC Input Mode (Run operation)	29
Static-Bypass Mode (Stop operation).....	29
Battery Backup Mode (on batteries)	30
EPO (Emergency Power Off) Function.....	30
Audible Alarm Functions	31
Display and Keys	32
Front Panel Layout	32
Liquid Crystal Display (LCD) Functions.....	32
Operating Keys.....	33
Light Emitting Diodes (LED)	33
Display Screens	34
Screen Arrangement.....	34
System Overview Screens.....	34
UPS Start-Up Screens Sequence.....	34
Data Display Screens	36
Special Display Screens	37

Data Setting Screens.....	38
System Warning Messages	44
System Fault Messages	45
Status Change Indications.....	46
UPS Protection System.....	47
System Protection Features	47
System Protection Functions	47
Preventive Maintenance/Parts Replacement	49
Preventive Maintenance	49
Parts Replacement	49
Optional Receptacle Panel Installation Instructions.....	50
External Layouts/Dimensions/Shipping Weights.....	51
Dimensional Data	51
Shipping Weights.....	51
Index	54

General Safety Instructions

DO NOT attempt to transport, install, operate, maintain or dispose of this equipment until you have read and understood all of the product safety information provided in this manual.

Symbols

The symbols listed below are used throughout this manual. When symbols are used in this manual they will include important safety information that must be carefully followed.



Safety Alert Symbol indicates that a potential personal injury hazard exists.



Prohibited Symbol indicates **DO NOT** take action.



Mandatory Symbol indicates that the following instruction is required.



Ground Symbol indicates the location of the equipment grounding conductor.



Electrical - Voltage & Shock Hazard Symbol indicates parts inside may cause electric shock.



Explosion Hazard Symbol indicates parts may explode.

Signal Words

The signal words listed below are used throughout this manual. When the words DANGER, WARNING, CAUTION and ATTENTION are used in this manual they will include important safety information that must be carefully followed.



DANGER

The word **DANGER** in capital letters preceded by the safety alert symbol indicates that an **imminently hazardous** situation exists, if not avoided, **will result in death or serious injury to personnel**.



WARNING

The word **WARNING** in capital letters preceded by the safety alert symbol indicates that a **potentially hazardous** situation exists, if not avoided, **could result in death or serious injury to personnel**.



CAUTION

The word **CAUTION** in capital letters preceded by the safety alert symbol indicates that a **potentially hazardous** situation exists, if not avoided, **may result in minor or moderate injury**.

CAUTION

The word **CAUTION** in capital letters without the safety alert symbol indicates a **potentially hazardous** situation exists, if not avoided, **may result in equipment and property damage**.

ATTENTION

The word **ATTENTION** in capital letters without the safety alert symbol indicates a **potentially hazardous** situation exists, if not avoided, **may result in equipment and property damage**.

IMPORTANT SAFETY INSTRUCTIONS

This manual contains important instructions for 3.6, 6, 8, 10, 14, 18, and 22 kVA Units that should be followed during the installation and maintenance of the UPS and its batteries.

Hardwire type UPS units are not equipped with an over-current protection device nor an output disconnect for the AC output. Therefore, a circuit breaker should be provided by the user between the UPS output and the load input. This device should be rated as follows:

240VAC RATING	3.6kVA	6kVA	8kVA	10kVA	14kVA	18kVA	22kVA
	20A	30A	40A	60A	80A	125A	150A

The nominal battery voltages for these models are as follows:

BATTERY VOLTAGE	3.6kVA	6kVA	8kVA	10kVA	14kVA	18kVA	22kVA
	216Vdc	216Vdc	288Vdc	288Vdc	288Vdc	288Vdc	288Vdc

Servicing of the batteries should only be performed by a qualified Toshiba Representative who is knowledgeable of batteries and the required precautions. Keep unauthorized personnel away from batteries. To arrange for battery replacement, contact your nearest Toshiba authorized service center.

- 1 Turn off, lockout, and tagout all not equipped before connecting the power wiring to the equipment ow when performing maintenance.
- 2 Hardwire type UPS units are not equipped with an over-current protection device, nor do they have an output disconnect for the AC output. Therefore, a user-installed circuit breaker should be provided between the UPS output and the load input.
- 3 The maximum ambient operating temperature is 104 °F (40 °C).
- 4 Battery servicing should be performed by qualified Toshiba Representative only.
- 5 Unauthorized personnel should not service batteries.
- 6 Contact your Toshiba authorized service center for battery replacement.

QUALIFIED PERSONNEL ONLY

Qualified personnel is one that has the skills and knowledge relating to the construction, installation, operation, and maintenance of the electrical equipment and has received safety training on the hazards involved (Refer to the latest edition of NFPA 70E for additional safety requirements).

Qualified personnel shall:

- 1 Have read the entire operation manual.
- 2 Be trained and authorized to safely energize, de-energize, ground, lockout and tag circuits and equipment, and clear faults in accordance with established safety practices.
- 3 Be trained in the proper care and use of protective equipment such as safety shoes, rubber gloves, hard hats, safety glasses, face shields, flash clothing, etc., in accordance with established safety practices.
- 4 Be trained in rendering first aid.
- 5 Be knowledgeable of batteries and the required handling and maintenance precautions.

For further information on workplace safety visit www.osha.gov.



CAUTION

Misuse of this equipment could result in human injury and equipment damage. In no event will Toshiba Corporation be responsible or liable for either indirect or consequential damage or injury that may result from the use of this equipment.



CAUTION



DO NOT dispose of the battery module in a fire. The batteries inside may explode.



CAUTION

DO NOT open or mutilate the batteries. Released electrolyte is harmful to the eyes and skin and could also be toxic.

To be performed by **Qualified Personnel Only**:

- 1 Verify that the UPS is off and that the power cord is disconnected from the power source.
- 2 Remove watches, rings or other metal objects.
- 3 Use tools with insulated handles to prevent inadvertent shorts.
- 4 Wear rubber gloves and boots.
- 5 DO NOT place tools or any metal parts on top of batteries.
- 6 Determine if the battery is inadvertently grounded. If inadvertently grounded, remove source of ground.



WARNING

Contact with any part of a grounded battery can result in electrical shock.

The likelihood of shock will be reduced if such grounds are removed prior to installation or maintenance.

INSTRUCTIONS IMPORTANTES CONCERNANT LA SÉCURITÉ

CONSERVER CES INSTRUCTIONS

Cette notice contient des instructions importantes concernant la sécurité.



ATTENTION

Une batterie peut présenter un risque de choc électrique, de brûlure par transfert d'énergie.



ATTENTION

L'élimination des batteries est réglementée. Consulter les codes locaux à cet effet.

Product Description

An uninterruptible power system is a system that is installed between the commercial power and the load equipment. The UPS provides steady AC output power during commercial power short-term blackouts or brownouts. This power is provided for a long enough time so that the load can be shut down in an orderly fashion. This prevents loss of data and possible damage to both hardware and software.

During normal operation, the UPS uses commercial AC power. In addition, it takes in all of the high voltage spikes and transients caused by switching and faults, and all of the common-mode and normal mode noise which is associated with commercial AC power. The UPS converts it all to flat DC power. From this power, the UPS charges its batteries and generates its own extremely high quality AC waveform output. The result of this process is maximum power conditioning and regulation.

If the AC power supplied to the UPS drops below a specified voltage level, the unit's batteries automatically begin supplying power instead of receiving it. This insures that the loads connected to the UPS continue to receive power with no interruption. When AC input power becomes available again, operation returns to normal. The unit's batteries begin to recharge so they will be ready for the next power interruption.

Application and Use

Toshiba's 1600EP Series of on-line uninterruptible power system (UPS) systems provide continuous computer-grade AC power in a compact, high performance, and energy efficient unit. The UPS unit assures safe and reliable operation of critical office equipment. This can range from word processors and personal computers to mini-computers and local area networks. All units feature an audible alarm which sounds if the battery voltage drops below standard during use. This is an additional aid to help in retaining the valuable office data banks. All units allow for computer interfacing.

Output Rating

Toshiba's 1600EP Series (208/240V) offers UPS models with the following capacities:

MODEL	Output Capacity @ 240V	Output kW @ .85PF 240V
UE3G2L036C61T	3.6 kVA	3.1 kW
UE3G2L060C61T	6 kVA	5.1 kW
UE3G2L080C61T	8 kVA	6.8 kW
UE3G2L100C61T	10 kVA	8.5 kW
UE3G2L140C61T	14 kVA	11.9 kW
UE3G2L180C61T	18 kVA	15.3 kW
UE3G2L220C61T	22 kVA	18.6 kW

Power Backup

When an electrical power failure occurs, the UPS's internal batteries automatically supply back-up power to the load without interruption. For example, when used to support a computer, the UPS back-up assures enough additional time to complete the activity and store the data. This allows an orderly shutdown after a power failure has occurred.

Power Conditioning

When commercial power is present, the UPS supplies conditioned power to the load while maintaining its batteries in a charged condition. The UPS protects against the normal, everyday problems associated with heavy use of raw commercial power, including power sags, surges, signal interference, and spikes. This protection keeps power-line problems from reaching your load, where they can cause equipment to operate erratically, or damage software and hardware.

Inspection/Storage/Disposal

Inspection

Upon receipt of the UPS, an inspection for shipping damage should be performed. Use caution when removing the unit from the pallet. Refer to labels or documentation attached to packing material.

Unpacking

Check the unit for loose, broken, bent or otherwise damaged parts. If damage has occurred during shipping, keep all original crating and packing materials for return to the shipping agent. The warranty does not apply to damage incurred during shipping. Ensure that the rated capacity and the model number specified on the nameplate conform to the order specifications.

Storage

During periods of non-use, the following guidelines are recommended for storage.

Storage Preparation

- 1 Power up the UPS and allow it to operate with no load for 24 hours to fully charge the batteries.
- 2 Stop the unit (see "Stop Operation" on page 29).
- 3 Place the MCCB switch (see page 52 for location) in the "Off" position.

Storing Conditions

- For best results, store the UPS in the original shipping container and place on a wood or metal pallet.
- Storage temperature: -20 to 40 °C (-4 to 104 °F).
- The optimum storage temperature is 21 °C (70 °F). A higher ambient temperature will require recharging more frequently during storage.

Avoid the following storage locations:

- Locations that are subject to extreme temperature changes or high humidity.
- Locations that are subject to high levels of dust or metal particles.
- Locations that are subject to excessive vibration.
- Inclined floor surfaces.

Storage Maintenance

- If stored at an ambient temperature less than 20 °C (68 °F), recharge the batteries every 9 months.
- If stored at an ambient temperature of 20 – 30 °C (68 – 86 °F), recharge the batteries every 6 months.
- If stored at an ambient temperature of 30 – 40 °C (86 – 104 °F), recharge the batteries every 3 months.

Disposal

Please contact your local or state environmental agency for details on disposal of electrical components and packaging in your particular area.

It is illegal to dump lead-acid batteries in landfills or dispose of improperly.

Please help our Earth by contacting the environmental protection agencies in your area, the battery manufacturer, or call Toshiba toll-free at (800) 231-1412 for more information about recycling.

Installation Precautions



CAUTION

- 1 Install the unit in a well-ventilated location; allow at least 10 cm (4 inches) on all sides for air ventilation and for maintenance.
- 2 Install the unit in a stable, level and upright position that is free of excessive vibration.
- 3 Install the unit where the ambient temperature is within the range specified on pages 21 and 24.
- 4 DO NOT install the UPS in areas that are subject to high humidity.
- 5 DO NOT install the UPS in areas that allow exposure to direct sunlight.
- 6 DO NOT install the UPS in areas that allow exposure to high levels of airborne dust, metal particles, or flammable gases.
- 7 DO NOT install the UPS in areas near sources of electrical noise. Ensuring a proper earth ground will reduce the effects of electrical noise and will reduce the potential for electrical shock.
- 8 DO NOT install the UPS in areas that would allow fluids or any foreign object to get inside the UPS.
- 9 The UPS generates and can radiate radio-frequency energy during operation. Although RFI noise filters are installed inside of the unit, there is no guarantee that the UPS will not influence some sensitive devices that are operating near by. If such interference is experienced, the UPS should be installed farther away from the affected equipment and/or powered from a different source than that of the affected equipment.
- 10 The user should provide output over-current protection for hardwired UPS systems. See the section titled Specifications on page 20 and 23 for the device rating.
- 11 After ensuring that all power sources are turned off and isolated in accordance with established lockout/tagout procedures, connect the power source wiring of the correct voltage to the input terminals of the UPS.
- 12 Connect the output terminals of the UPS to the load (refer to NEC Article 300 – Wiring Methods and Article 310 – Conductors For General Wiring). Size the branch circuit conductors in accordance with NEC Table 310.16.

Conductor Routing and Grounding

- 1 Use separate metal conduits for routing the input power, output power, and control circuits.
- 2 Follow the wire size and tightening torque specifications listed on page 16.
- 3 Always ground the unit to reduce the potential for electrical shock and to help reduce electrical noise.
- 4 A separate ground cable should be run inside the conduit with the input power, output power, and control circuits.



WARNING



THE METAL OF CONDUIT IS NOT AN ACCEPTABLE GROUND.

Operating Precautions

- 1 The UPS should not be powered up until the entire operation manual has been read.
- 2 The voltage of the input power source must be within the range of +10% to -30% of the rated input voltage. The input frequency must be within the rated input frequency range. Voltages and frequencies outside of the permissible range may activate the internal protection devices.
- 3 The UPS should not be used with a load that has a rated input that is greater than the rated output of the UPS.
- 4 **DO NOT** use the UPS to provide power to motors that require high starting current or with motors that require a long starting time, such as vacuum cleaners and machine tools (over sizing the UPS for lock rotor current would be required).
- 5 **DO NOT** insert metal objects or combustible materials in the ventilation slots of the UPS.
- 6 **DO NOT** place, hang, or paste any objects on the exterior surfaces of the UPS.
- 7 The capacitors of the UPS maintain a residual charge for a while after turning the UPS off. The required discharge time for each UPS typeform is provided via a cabinet label and a **CHARGE LED**. Wait for at least the minimum time indicated on the label and ensure that the **CHARGE LED** has gone out before opening the door of the UPS once the UPS power has been turned off.
- 8 **DO NOT** attempt to disassemble, modify, or repair the UPS. Call your Toshiba sales representative for repair information.
- 9 Turn the power on only after attaching **ALL** of the covers.
- 10 **DO NOT** remove any covers of the UPS when the power is on.
- 11 If the UPS should emit smoke or an unusual odor or sound, turn the power off immediately.
- 12 The heat sink and other components may become extremely hot to the touch. Allow the unit to cool before coming in contact with these items.
- 13 Warning signs should be placed on or near the load as a notification that the load is being powered by the UPS.
- 14 Additional warnings and notifications shall be posted at the equipment installation location as deemed required by **Qualified Personnel**.



WARNING

While operating in the inverter mode, placing the breaker in the **OFF** position will switch the UPS to the battery backup mode. The output of the UPS will continue uninterrupted to the load. The unit must be in the bypass mode at the time that the breaker is placed in the **OFF** position for the UPS to shutdown power to the load.



CAUTION

After an Emergency Power Off (EPO), do not reset the breaker until the UPS has been fully discharged. The UPS could be damaged if the unit is not fully discharged before the breaker is reset.

UPS Connections

Terminal Block

The following illustration is a detail view of the terminal block and wiring connections used for 208/240 volt units (see pages 52-53 for terminal block location).

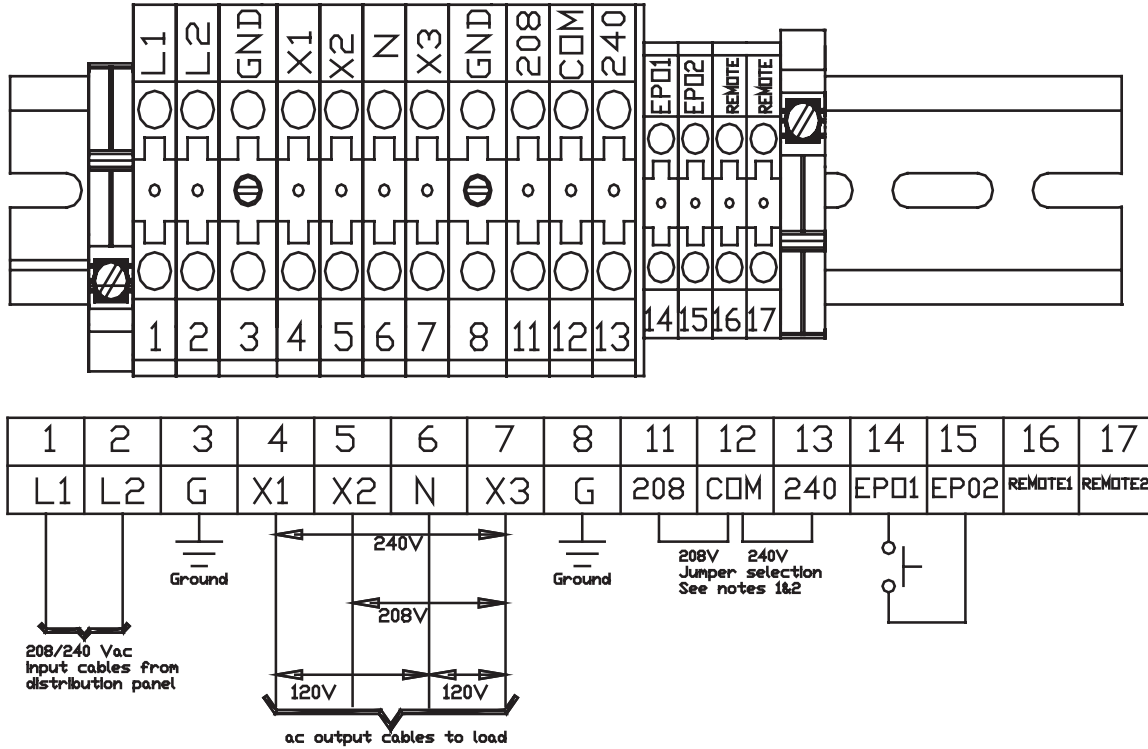

- NOTE**
- 1 If AC input power is 240Vac rated, terminals 12 and 13 must be shorted by jumper wire DO NOT jumper terminal 11 to 12 or 13.
 - 2 If AC input power is 208Vac rated, terminals 11 and 12 must be shorted by jumper wire DO NOT jumper terminal 13 to 12 or 11. Factory Setting is 208Vac.

Wire Size and Tightening Torque

Use the following table to select the recommended wire size and terminal lug tightening torque for I/O wire connections.

Note: The bold number in () is the maximum size wire that the terminal block can accommodate.

Item	Terminal Number	AWG 3.6kVA	AWG 6kVA	AWG 8kVA	AWG 10kVA	AWG 14-18kVA	AWG 22kVA	Tightening Torque (Pounds-Inches)
AC Input Lines	1 and 2	(8) 12	(8) 10	(1/0) 8	(1/0) 6	(1/0) 4	(1/0) 1	14.2
AC Output Lines	4, 5, and 7	(8) 12	(8) 10	(1/0) 8	(1/0) 6	(1/0) 4	(1/0) 1	14.2
AC Output Neutral	6	(8) 12	(8) 10	(1/0) 8	(1/0) 6	(1/0) 4	(1/0) 1	14.2
Ground	3 and 8	(8) 12	(8) 10	(1/0) 8	(1/0) 4	(1/0) 4	(1/0) 1	14.2
EPO Switch	14 and 15	16	16	16	16	16	16	9.0
Remote Switch	16 and 17	16	16	16	16	16	16	9.0

(1 pound-inch = 0.11 Newton-meter)

Communication Interfaces

Remote Contacts

The remote contacts interface is provided as a set of solid state relay switch contacts. The switches are available through a DB9 male connector on the rear of the UPS. The following chart shows the pin assignment for each signal.

MAXIMUM CURRENT CARRYING CAPACITY OF THE SWITCH

Voltage	Current
48Vdc Peak	100mAdc peak
30Vac rms (42Vac peak)	70mAac rms (100mA peak)

DB9 MALE CONNECTOR OUTLINE (FACING CONNECTOR)

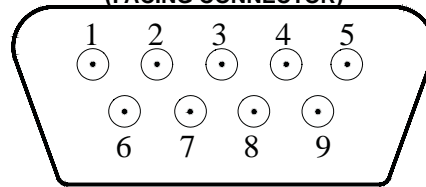

Pin	Signal Function	Logic	In the UPS
1	Fault Signal	Closed when fault detected	
2	UPS stop common	Backup stop when the level changes from Low (-3 to -15V) to High (+3 to +15V)	
3	UPS stop signal input		
4	Normal input power supply	Closed with normal supply power	
5	Signal common	Common signal return	
6	Bypass operation	Closed during bypass operation	
7	Battery voltage drop	Closed at voltage drop	
8	UPS operation	Closed during inverter operation	
9	Power failure signal	Closed at power failure	

NOTE Pin "switches" are shown in their inactive states. For example, if battery voltage is low, pin 7 will be connected to pin 5.

UPS Stop Signal Operation

When the UPS stop signal is sent to the UPS through pin 2 and 3 of the external contact interface, it is possible to automatically reset the following operating systems (OS), which can automatically implement the shutdown function and restart the operation:

Applicable OS: Windows NT, IBM OS/2 LAN server, LANtastic

When the power fails, the OS detects the power failure signal from the UPS and starts the shutdown process.

At the end of the shutdown process, the OS sends a stop signal to the UPS, and the UPS stops.

When the power recovers, the UPS automatically starts output and restarts the OS. Even when the power recovers while in a shutdown process, the UPS temporarily cuts off the output (10 - 20 seconds) and then restarts the OS within 10 minutes after the recovery from power failure. In this case the UPS cuts off output even with normal input power. Connect the UPS stop signal of the external contact interface only for the automatic processing so that the UPS output will not be cut off by mistake. If a stop signal is sent to the UPS ten minutes or more after the recovery from a power failure, then the UPS ignores this signal and continues to output power.

If the computer is started/restarted within 10 minutes after the recovery from a power failure, the power supply may be reset while the computer is restarting.

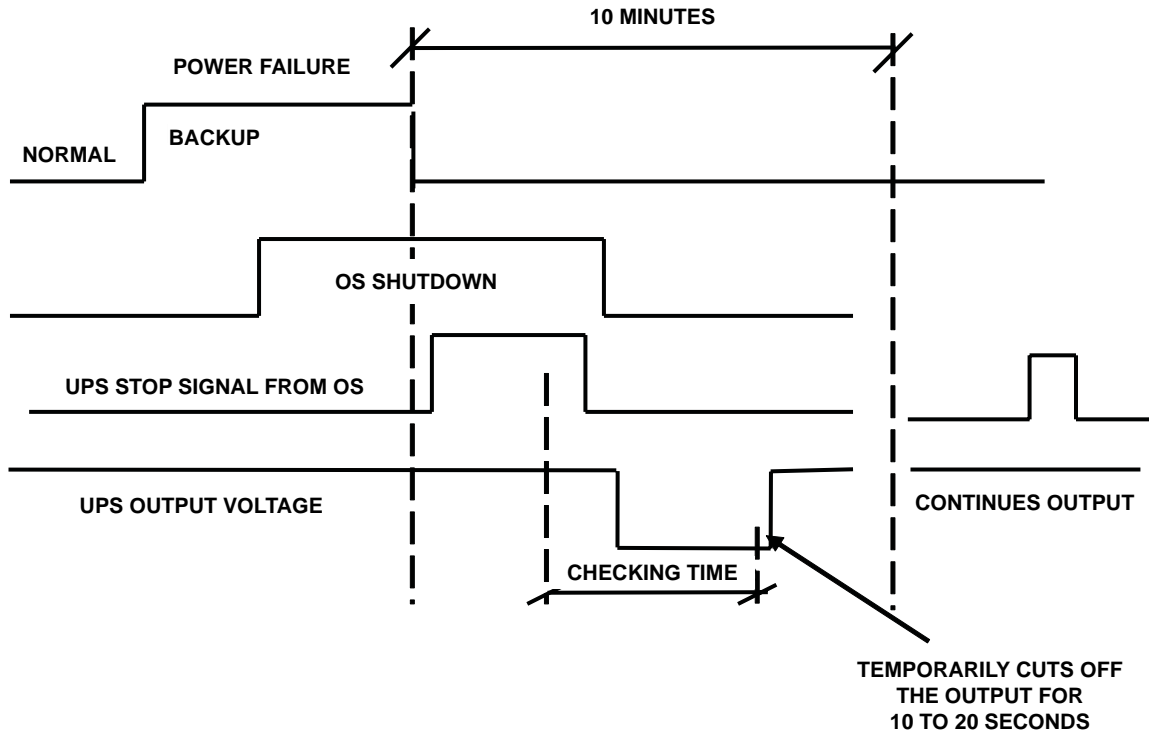

RS-232C

The RS232C port can be used by authorized service personnel. The port is provided using a DB9 female connector located on the rear of the UPS. For reference, the pinout of the connector is illustrated below.

RS-232C CONNECTOR PIN ASSIGNMENT

Pin	I/O	Symbol	Description
1	This pin is not used		
2	Input	RXD	Receive data
3	Output	TXD	Transmit data
4	Output	DTR	Data terminal ready
5	-	SG	Signal ground
6	Input	DSR	Data set ready
7	Output	RTS	Request to send
8	Input	CTS	Clear to send
9	This pin is not used		

DB9 FEMALE CONNECTOR OUTLINE
(FACING CONNECTOR)

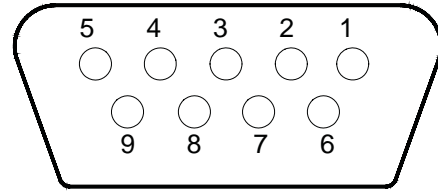

RemotEye Network Card

The RemotEye is an optional network card for Toshiba UPS. This card slides into a slot located on the back side (pages 52-53) of the UPS. The card provides a network, or LAN-based communication interface for the UPS. When installed, the UPS can be managed remotely using the common SNMP and HTTP web-based network protocols. The following diagram shows the flow of the Network Management Station.

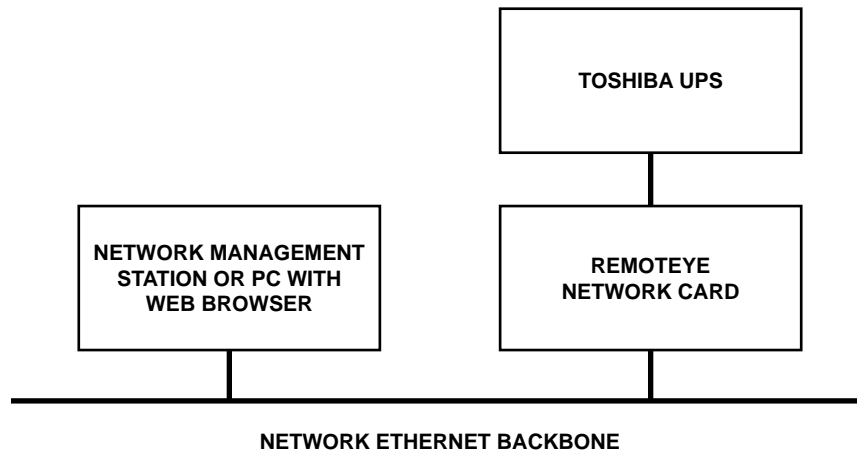

NOTE The UPS communication mode setting must be set to "SNMP" mode when using the RemotEye network card (see Comm Mode variable in the 'Data Setting Screens' on page 38).

UPS Specifications

STANDARD MODELS: 3.6kVA; 6kVA; 8kVA

Capacity	3.6kVA (3.1kW)*	6kVA (5.1kW)*	8kVA (6.8kW)*
General			
Topology	True On-line		
Certifications	UL, CUL, ISO 9001, NEMA/PE1-1993		
Input Characteristics			
Input Voltage	Single-phase, 208/240 VAC, +10% to -30%*		
Input Frequency	45-65 Hz (auto-sensing)		
Input Capacity	3.6 kVA	6 kVA	8 kVA
Input Power Factor	> 0.95 for all loads		
Current THD (linear load)	< 5%		
Included AC Input Breaker Rating	30 A / 277 V	50 A / 277 V	60 A / 277 V
Battery Characteristics			
Battery Type	Valve Regulated Lead Acid, Flame Retardant		
Backup time, fully charged @ 0.7 power factor, 77°F	3.6 kVA	6 kVA	8 kVA
	14 min minimum**	7 min minimum**	
Backup time, fully charged @ 0.85 power factor, 77°F	10 min minimum**	7 min minimum**	
Recharge Time	24hr. (full), 12hr.(90%) for internal batteries only***		
Battery Voltage (Nominal)	216 VDC	216 VDC	288 VDC
Output Characteristics			
Output Voltage	Single-phase, 240/208/120 volts		
Output Voltage Regulation	± 3%		
Output Frequency	±0.5 Hz/1 Hz/1.5 Hz (factory or authorized service center selectable only)		
AUTO/MAN Frequency	Factory or authorized service center selectable only		
Voltage THD	< 3% for linear load; < 6% for non-linear load		
Common-Mode Noise	< .5 Vrms		
Rated Load Power Factor	0.85 (0.6 - 1.0) lagging		
Efficiency (AC-DC-AC)	> 83% (without battery charge)		
Voltage Transient	< ±8% (Load of 0 to 100 %)		
Rated Output Current (rms)	15.0 A	25.0 A	33.3 A
Max. Peak Output Current	45.0 A	75.0 A	100.0 A
Inverter Overload Capacity	125%-30 sec/150%-10 sec		
Bypass Overload Capacity	125%-10 min./1000%-1 cycle		
Crest Factor	3.0		

STANDARD MODELS: 3.6kVA; 6kVA; 8kVA (CONT'D)

Capacity	3.6kVA (3.1kW)*	6kVA (5.1kW)*	8kVA (6.8kW)*
Environment			
Operating Temperature (15 – 25° C recommended)	60Hz		50Hz
	0 – 40 °C		0 – 33 °C
Storage Temperature	-20 – 40 °C (-4 to 104 °F)		
Installation Area	To be installed in a well ventilated area free of airborne dust, metal particles or flammable gas, allow at least 4 inches on all sides.		
Operating Humidity	30 – 90% (no condensation)		
Altitude	< 1000 m above sea level****		
Acoustical Noise	50 dB (A) maximum @ 1 meter from front panel		
Heat Generation	1588 BTU/Hr	2610 BTU/Hr	3482 BTU/Hr
Operation Diagnosis			
Battery Check	Performed on start up, by schedule, on-demand (user configurable)		
Input OV Protection	Standard		
Battery +/-	UPS calculates battery replacement time based upon battery ambient temperature (LCD display, LED and beeps)		
Internal Temperature	UPS gives indication of internal temperature, alarm when high temp		
Event Data Storage	64-Supply Mode, 32-Back up, 16-Faults		
Applications			
Switches	Generator compatible		
Bypass Switch			
Bypass Disable	Static switch <1/4 cycle (50Hz:5ms/60Hz:4.16ms)		
Automatic Retransfer	Factory or authorized service center selectable only		
User Interface	Provided (can be disabled from front panel)		
Real Time Clock			
Schedule Operation	Standard, Minimum 3 days memory backup during power loss		
RUN/STOP Disable	Schedule ON/OFF operation of UPS using communication software		
Autostart	UPS has option for UPS to start automatically when AC is applied		
Remote ON/OFF	Standard, external terminal		
LED Display	4 LED's indicating input/output condition, warning and battery operation		
LCD Screen	16 characters x 2 lines		
UPS Operation: 6 Keys	Run/Stop, Set/Monitor, Shift/Select, Del/Page Down, Reset/Page Up		
Buzzer Volume	Low, High, Mute; Selectable by keypad		
Power Connections	Hard wire (Standard)		
Emergency Power Off	Standard (Terminal contacts only)		
Remote Contacts	Standard (INV, BYP, BATT, LB, AC, FLT)		
RS232 ASCII Interface	Standard		

STANDARD MODELS: 3.6kVA; 6kVA; 8kVA (CONT'D)

Capacity	3.6kVA (3.1kW)*	6kVA (5.1kW)*	8kVA (6.8kW)*
Mechanical Design			
Enclosure	Enclosure of unit made from sheet metal meeting NEMA1 and UL Type 1		
Size (HxWxD) Inches (max)	27.5 x 10 x 33		28.25 x 13 x 33.5
Paint System	Powder coating.		
Fan Panel	Panel mounted on back of UPS to allow for easy replacement of fans without turning UPS off.		
Battery System			
Battery Replacement	Slide out battery packs accessible from front of UPS, factory or authorized service center serviceable only		
Battery Packs	Designed for battery acid leakage containment with (6) batteries per pack.		
Battery Pack Size			
HxWxD)Inches(max)	5 x 7.3 x 18.2		
Battery Pack Quantity	3	3	4
Battery Manufacturer	Energysys		
Battery Type	NPX-35		
Toshiba's Part Number for Battery Pack	51896		

(*) Input/output figures rated for 240 volts. Output ratings given for 0.85PF are only valid when the input voltage is greater than 204 volts; otherwise, ratings given for 0.70PF are applicable.

(**) Battery backup time may vary depending on the operating conditions and ambient temperature at the installation site.

(***) An initial charge time of 24 hrs. is necessary to obtain proper battery performance level before unit is placed in operation

(****)At 6600 ft (2000 m) above sea level, output capacity should be derated by 3%.

STANDARD MODELS: 10kVA; 14kVA; 18kVA; 22kVA (CONT'D)

Capacity	10kVA (8.5kW)*	14kVA (11.9kW)*	18kVA (15.3kW)*	22kVA (18.7kW)*
General				
Topology	True On-line			
Certifications	UL, CUL, ISO 9001, NEMA/PE1-1993			
Input Characteristics				
Input Voltage	Single-phase, 208/240 VAC, +10% to -30%*			
Input Frequency	45-65 Hz (auto-sensing)			
Input Capacity	10 kVA	14 kVA	18 kVA	
Input Power Factor	> 0.95 for all loads			
Current THD (linear load)	< 5%			
Included AC Input Breaker rating	63 A / 277 V	100 A / 277 V		125 A / 277 V
Battery Characteristics				
Battery Type	Valve Regulated Lead Acid, Flame Retardant			
Backup time, fully charged @ 0.7 power factor, 77 F	10 kVA	14 kVA	18 kVA	22 kVA
	7 min minimum**			5 min
Backup time, fully charged @ 0.85 power factor, 77 F	5 min minimum**	7 min minimum**	5 min minimum**	3 min minimum**
	24hr. (full), 12hr.(90%) for internal batteries only***			
Recharge Time	24hr. (full), 12hr.(90%) for internal batteries only***			
Battery Voltage (Nominal)	288 VDC			
Output Characteristics				
Output Voltage	Single-phase, 240/208/120 volts			
Output Voltage Regulation	±3%			
Output Frequency	±0.5Hz/1Hz/1.5Hz (factory or authorized service center selectable only)			
AUTO/MAN Frequency	Factory or authorized service center selectable only			
Voltage THD	< 3% for linear load; < 6% for non-linear load			
Common-Mode Noise	< .5 Vrms			
Rated Load Power Factor	0.85 (0.6 - 1.0) lagging			
Efficiency (AC-DC-AC)	> 83% (without battery charge)			
Voltage Transient	< ±8% (Load of 0 to 100 %)			
Rated Output Current (rms)	41.6 A	58.0 A	75.0 A	91.6 A
Max. Peak Output Current	125 A	174 A	225 A	275 A
Inverter Overload Capacity	125%-30 sec/150%-10 sec			
Bypass Overload Capacity	125%-10 min./1000%-1 cycle			
Crest Factor	3.0			

STANDARD MODELS: 10kVA; 14kVA; 18kVA; 22kVA (CONT'D)

Capacity	10kVA (8.5kW)*	14kVA (11.9kW)*	18kVA (15.3kW)*	22kVA (18.7kW)*
Environment				
Operating temperature (15 – 25° C recommended)	60 Hz (0 – 40 °C) ; 50Hz (0 – 33 °C)			
Storage Temperature	-20 – 40 °C (-4 to 104 °F)			
Installation Area	To be installed in a well ventilated area free of airborne dust, metal particles or flammable gas, allow at least 4 inches on all sides			
Operating Humidity	30 – 90% (no condensation)			
Altitude	< 1000m above sea level****			
Acoustical Noise	50 dB (A) maximum @ 1 meter from front panel			
Heat Generation	4352 BTU/Hr	6092 BTU/Hr	7832 BTU/Hr	6900 BTU/Hr
Operation Diagnosis				
Battery Check	Performed on start up, by schedule, on-demand (user configurable)			
Input OV Protection	Standard			
Battery Lifetime	UPS calculates battery replacement time based upon battery ambient temperature (LCD display, LED and beeps)			
Internal Temperature	UPS gives indication of internal temperature, alarm when high temp			
Event Data Storage	64-Supply Mode, 32-Back up, 16-Faults			
Applications				
Switches	Generator compatible			
Bypass Switch				
Bypass Disable	Static switch <1/4 cycle (50Hz:5ms/60Hz:4.16ms)			
Automatic Retransfer	Factory or authorized service center selectable only			
User Interface	Provided (can be disabled from front panel)			
Real Time Clock				
Schedule Operation	Standard, Minimum 3 days memory backup during power loss			
RUN/STOP Disable	Schedule ON/OFF operation of UPS using communication software			
Autostart	UPS has option for UPS to start automatically when AC is applied			
Remote ON/OFF	Standard, external terminal			
LED Display	4 LED's indicating input/output condition, warning and battery operation			
LCD Screen	16 characters x 2 lines			
UPS Operation: 6 Keys	Run/Stop, Set/Monitor, Shift/Select, Del/(page down), Reset/(page up)			
Buzzer Volume	Low, High, Mute; Selectable by keypad			
Power Connections	Hard wire (Standard)			
Emergency Power Off	Standard (Terminal contacts only)			
Remote Contacts	Standard (INV, BYP, BATT, LB, AC, FLT)			
RS232 ASCII Interface	Standard			

STANDARD MODELS: 10kVA; 14kVA; 18kVA; 22kVA (CONT'D)

Capacity	10kVA (8.5kW)*	14kVA (11.9kW)*	18kVA (15.3kW)*	22kVA (18.7kW)*
Mechanical Design				
Enclosure	Enclosure of unit made from sheet metal meeting NEMA1 and UL Type 1			
Size (HxWxD) Inches (max)	28.25 x 13 x 33.5	39.1 x 17.5 x 34.8		
Paint System	Powder coating.			
Fan Panel	Panel mounted on back of UPS to allow for easy replacement of fans without turning UPS off.			
Battery System				
Battery Replacement	Slide out battery packs accessible from front of UPS, factory or authorized service center serviceable only			
Battery Packs	Designed for battery acid leakage containment with (6) batteries per pack.			
Battery Pack Size	5 x 7.3 x 18.2 (HxWxD) Inches (max)			
Battery Pack Quantity	4	8		
Battery Manufacturer	Energys			
Battery Type	NPX-35			
Toshiba's Part Number for Battery Pack	51896			

(*) Input/output figures rated for 240 volts. Output ratings given for 0.85PF are only valid when the input voltage is greater than 204 volts; otherwise, ratings given for 0.70PF are applicable.

(**) Battery backup time may vary depending on the operating conditions and ambient temperature at the installation site.

(***) An initial charge time of 24 hrs. is necessary to obtain proper battery performance level before unit is placed in operation

(****)At 6600 ft (2000 m) above sea level, output capacity should be derated by 3%.

Operating the UPS

Battery Backup Time and Discharge Process

The UPS batteries provide about 5-7 minutes of back-up time depending on the 1600EP unit kVA rating. These times are valid when the unit is operating under full load and at the rated power factor. The exact length of these times will depend on the UPS model used, condition of the batteries, amount and type of load, temperature and other variables. See battery backup time in 'Standard Specifications' beginning on pages 20-25.

The following illustration graphically shows the battery discharge process at full load conditions.

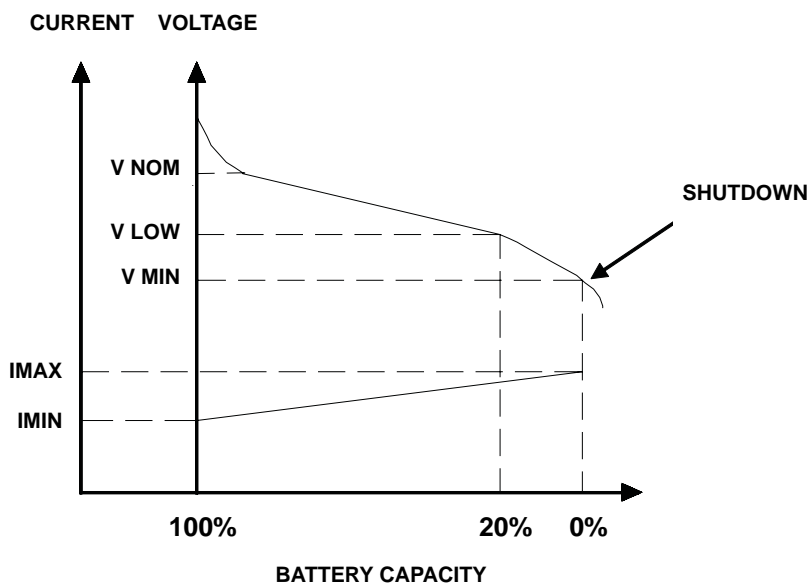

Battery Low Voltage Tolerances

Excessive discharge will cause the UPS battery voltage to drop. The chart shown below lists the voltage level at which each UPS low-voltage alarm will sound and also at what level the low-voltage condition will cause the unit to automatically shut down.

UPS Capacity	3.6kVA	6kVA	8kVA	10kVA	14kVA	18kVA	22kVA
Nominal voltage (Vnom)	216Vdc	216Vdc	288Vdc	288Vdc	288Vdc	288Vdc	288Vdc
Alarm voltage (Vlow)	192Vdc	192Vdc	246Vdc	246Vdc	246Vdc	246Vdc	246Vdc
Shutdown voltage (Vmin)	170Vdc	170Vdc	227Vdc	227Vdc	227Vdc	227Vdc	227Vdc

Starting the UPS

Turn the main circuit breaker (MCCB) on the back of the UPS (see pages 52-53) to the “ON” position (the breaker should normally remain in the “on” position).

Check that the **AC INPUT** LED on the front panel (see page 32 and 33) lights ‘green’. All LED’s on the front panel may light for a moment when the input breaker is turned “on”. This is normal. The UPS will now be supplying power in the bypass mode.



CAUTION

When running the UPS for the first time or after the power failure backup operation, charge the batteries for at least 24 hours (input breaker “on”) before operating the connecting load.

Using the UPS without charging the battery shortens the battery backup operation time, which could result in the destruction of data in case of a power failure.

Press **RUN** key to begin UPS operation (see page 34 for startup screens).



CAUTION

If the input breaker is turned off while UPS is in the bypass state, the output power stops. Any load devices will lose power.

Ensure that all sensitive loads have been previously shut down.

Stopping the UPS

To stop the UPS, press the **STOP** key approximately 1 second until the LED changes from green to “off”. The UPS is now in the bypass mode.

To completely stop the UPS, turn the input breaker at the back of the UPS to the “OFF” position.

Battery Recharging

The illustration below shows a graphical representation of the UPS battery recharge process after a full discharge.

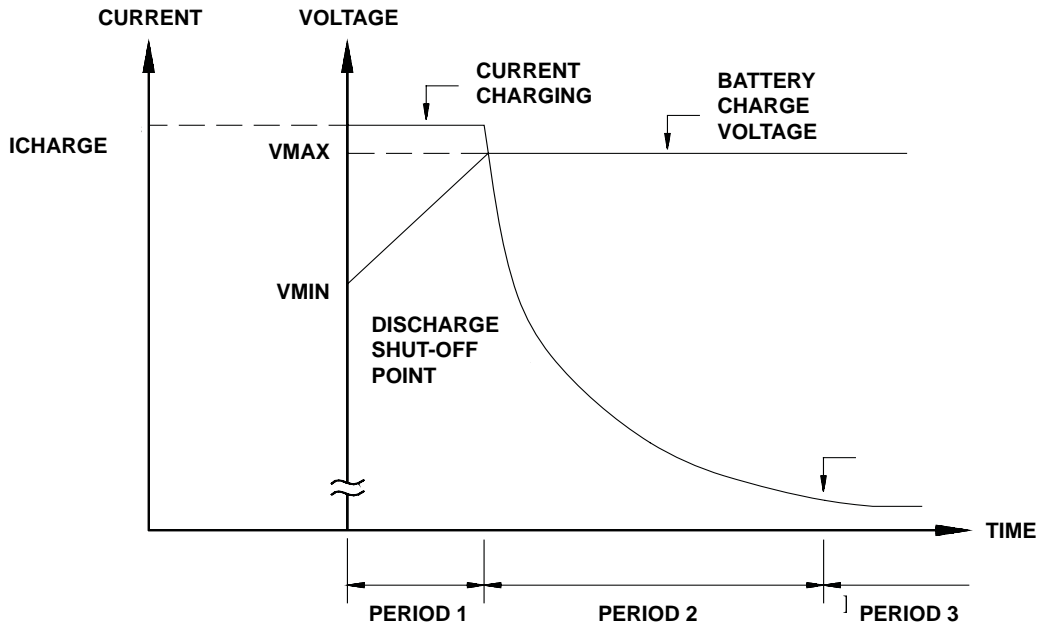

The recharge process usually consists of three periods. During the first period, the current is maintained at approximately 1 ampere. This current limit is the maximum value that can be used to charge the batteries (for minimal recharge time) while assuring safety and long battery life. In the second period, constant-voltage control starts and current gradually decreases as the batteries charge to their normal fully charged state. In the third period, a slight “trickle” current continues to flow into the batteries to keep them fully charged and “floating” at the normal V_{dc} level. A full recharge usually requires 24 hours (90% recharge in 12 hours) after a complete discharge.

The following chart shows the rated maximum and minimum battery voltages and the charge current for each of the sizes.

RATED BATTERY VOLTAGES

Model	V_{max}	V_{min}	I_{charge}
3.6kVA	245.7	170	1.0 amp
6kVA	245.7	170	1.0 amp
8kVA	327	227	1.0 amp
10kVA	327	227	1.0 amp
14kVA	327	227	1.0 amp
18kVA	327	227	1.0 amp
22kVA	327	227	1.0 amp

Online Mode

AC Input Mode (Run operation)

The following illustration shows circuit power flow when the UPS is operating normally in the AC input mode. The UPS rectifier, including a boost chopper circuit, converts AC input power to DC power. The boost chopper circuit maintains a constant voltage, with current limiting, for charging the batteries. It also supplies a DC voltage of the proper level to the inverter section. The inverter section generates a high quality sine wave output voltage. The unit's batteries are always maintained in a constantly charged state when the UPS is in the run operation mode.

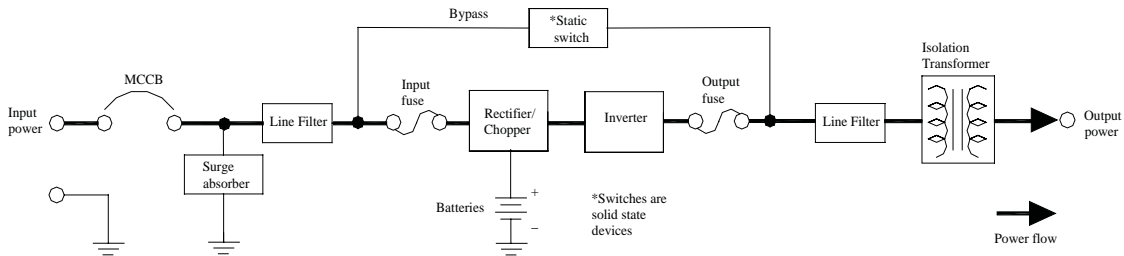

POWER FLOW IN AC INPUT MODE FOR ALL MODELS

Static-Bypass Mode (Stop operation)

If the UPS unit is severely overloaded or develops an internal fault, power flow is automatically switched from the unit's main circuit to the bypass circuit. Power flow through the bypass is shown in the following illustration. This change-over occurs automatically in less than 4 milliseconds in phase. The switching period is not long enough to cause interruptions to occur in most loads. If the power flow is transferred to the bypass circuit because of an overload and that overload condition ends within a specified period of time then the power flow will be transferred back to the **AC input mode (run operation)** automatically. If the power flow is transferred to the bypass circuit due to an external fault the UPS will shut down power through the bypass to the load and indicate a system fault message. If the power flow is transferred to the bypass circuit due to an internal fault the UPS will continue to supply power to the load through the bypass and indicate a system fault message (see system fault message DC-OC on page 48). If the power flow is transferred to the bypass circuit due to an overload condition (see system warning message OL: REDUCE LOAD on page 44 and AUTO RETRANSFER on page 46), then the power flow will automatically transfer from the UPS's bypass circuit back to the inverter circuit after removing the overload if set to do so (see auto-transfer setting on page 40).

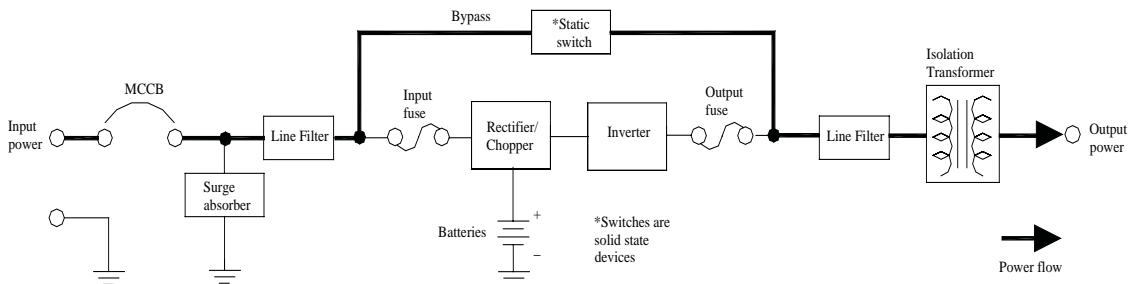

POWER FLOW IN BYPASS MODE FOR ALL MODELS

Battery Backup Mode (on batteries)

The following illustration shows power flow during the battery backup mode. When commercial AC power failures occur, the UPS's batteries instantly begin supplying DC voltage to the UPS's main inverter circuit. This circuit changes (inverts) the DC power into AC power. The AC power is available at the unit's output. This back-up process will continue until the UPS's battery voltage drops below a specific minimum level. When this occurs, the batteries will stop supplying power to the load. This minimum level is the rated minimum voltage (V_{min}). The rated battery voltage chart on page 28 shows (V_{min}). The battery backup time and discharge process is explained on page 28.

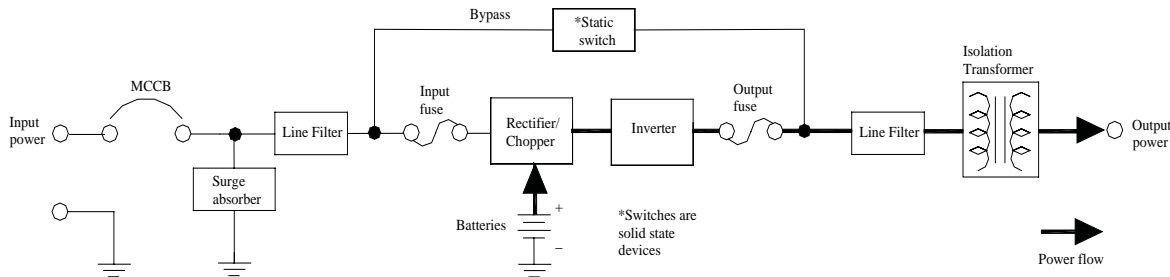

POWER FLOW IN BATTERY BACKUP FOR ALL MODELS

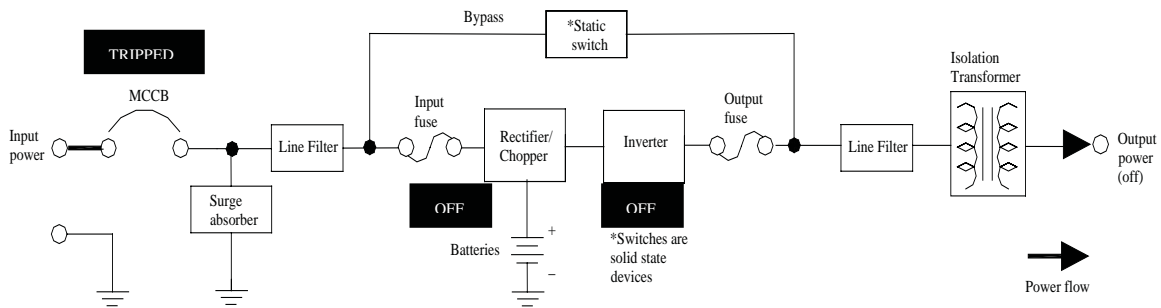

EPO (Emergency Power Off) Function

These units are equipped with terminals for receiving an emergency power-off (EPO) “closed contact” switch command from a remote location (see ‘terminal block details’ on page 16 and terminal block location on page 53-54). This safety feature enables quick shut-down of the UPS's AC output and battery circuits. Usually the emergency power off switch is installed in a central location that is easily accessible to personnel concerned with the operation of the UPS unit and the load equipment connected to it. The EPO function is initiated by pressing the switch to the closed “shutdown” position. The effect of using the EPO switch is the same whether the UPS unit is in the



Audible Alarm Functions

Audible alarms will sound when the UPS is in the battery backup mode, has a fault, has low battery voltage, or is in an overload condition. The following chart shows the audible alarm pattern durations for each condition. Time units are shown in seconds.

The audible alarm can be silenced by pressing  +  key on the front panel (see page 32).

AUDIBLE ALARMS

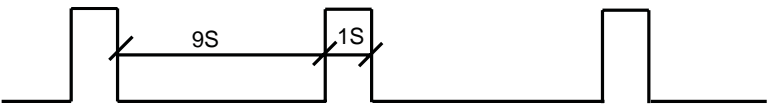
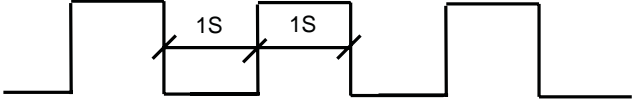
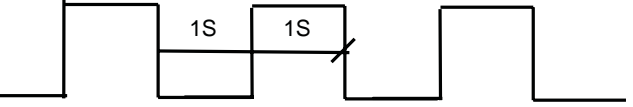
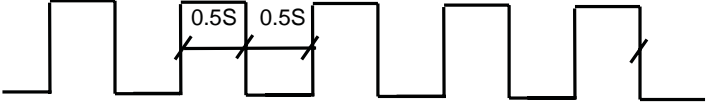
Condition	Audible Pattern
UPS in battery Backup mode	
UPS low Battery voltage	
Overload	
Fault	

Display and Keys

Front Panel Layout

The front panel consists of several elements for monitor and operation of the UPS. Panel components are shown in the illustration below:

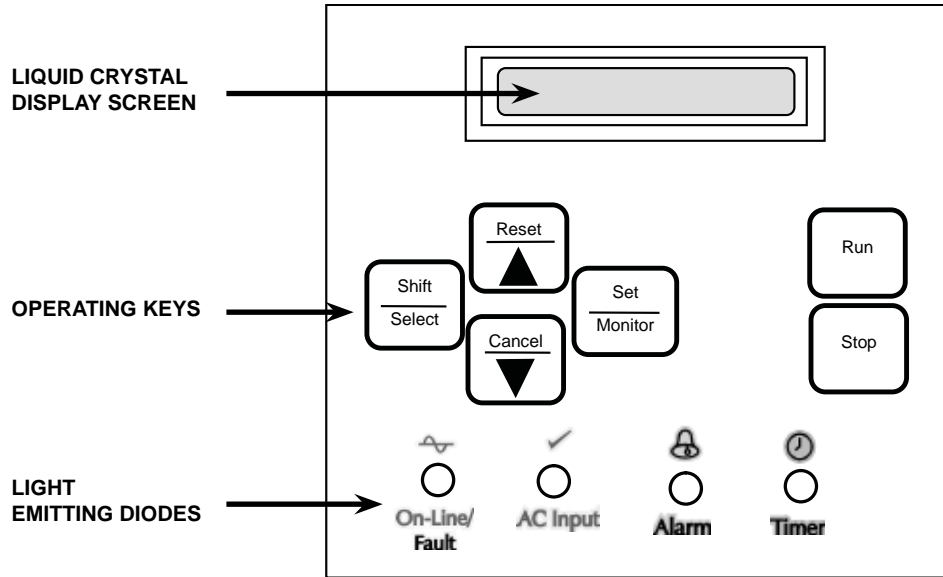





Liquid Crystal Display (LCD) Functions

The LCD screen is a 2-line by 16-character wide liquid crystal display. The LCD displays information about the operation of the UPS. It should be used in conjunction with the LED display (see page 33, 44-45) and the audible alarms (see page 31) for total system monitoring. The LCD screen displays information which may be shown only on specific lines of the display. This information is determined by the UPS operating mode and conditions. These messages are shown in the LED displays and LCD screens on pages 33 through 46.

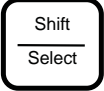
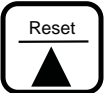

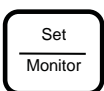
Operating Keys

Refer to this illustration for all UPS front panel operating procedures.

Key	Functional Description
	Press and hold this key while pressing one of the other keys to execute the function marked above the upper line of the key. Pressing this key alone enters the mode set on the internal data setting LCD screen (see page 38).
	Scrolls the display upward or with shift key resets the display.
	Scrolls the display downward or with shift key cancels the preceding operation.
	Press and hold this key to view the Data Display Screens (see page 36). Continue to press this key to access the Data Setting Screens (see page 38).
	Runs the UPS or with shift key silences the trouble indicator audio alarm.
	Stops the UPS and switches to bypass mode.

Light Emitting Diodes (LED)

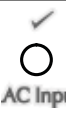
The following table describes the various LED behaviors and the system indications they provide.

LED	Behavior	Significance/Meaning
	Lights in green (Run)	Normal UPS (inverter) in operation
	Flashes in green	UPS output off
	Lights in red	UPS failure (no output)
	LED "OFF" (Stop)	Bypass operation on (inverter off)
	Lights in green (Run)	Normal UPS input AC voltage
	Flashes in green	UPS input AC overvoltage
	LED "OFF" (Stop)	UPS input AC undervoltage (power failure)
	Lights in amber	Warning
	Flashes in amber	Warning
	LED "OFF" (Stop)	Normal UPS (Inverter) in operation
	Lights in green	Schedule/timer setting
	Flashes in green	Execution notice of reserved operation (5 mins. in advance)
	LED "OFF"	No schedule/timer setting

Display Screens

Screen Arrangement

The display screens are organized into three groups that can be cyclically selectable by pressing the “SELECT” key. The groups are:

SCREEN ARRANGEMENT GROUPS		
1	System Overview Screens	Provides operational status summary
2	Data Display Screens	Provides detailed UPS data monitoring
3	Data Settings Screens	Provides system configuration

System Overview Screens

The System Overview Screens provide a summary of the current operational state of the UPS. Only one of the several possible overview screens is available at any moment. The current screen is automatically determined based upon the UPS state.

UPS Start-Up Screens Sequence

The Start-Up Screens consist of a series of automatically sequencing ‘System Overview Screens’. These screens notify operator of steps taken by UPS during its initialization. The sequence of Start-Up screens begins when AC input power is detected at UPS input.

If the correct AC input power is available and no abnormal operating conditions are present then the following system message will be displayed on the LCD screen.

TOSHIBA 1600 UPS
INITIALIZING...

Next, the LCD will report the current date and time. If necessary, the proper date and time can be set from the ‘Data Settings Screens’ (see pages 38 and 41 for details). The date and time appear using the format depicted in the following example:

11/04/2001(WED)
15.:22:47

Next, the LCD will report the current UPS Operational Mode and the current percentage of the maximum UPS capacity being supplied. Initially, the UPS is in bypass mode, and the following screen will appear:

BYPASS OPERATION
LOAD###%

NOTE: If input voltage is removed while UPS is in the Bypass Mode then the output stops.

Only if the UPS is instructed to enter its online (normal) mode, will the UPS attempt transfer into such operation mode. To enter the normal mode, the **“RUN”** key is pressed or the **“AUTO RUN”** has been configured to **“YES”** (AUTO RUN setup is described in the ‘Data Screen Settings’ actions on pages 38 - 43. If either condition exists, the following screen will appear:

UPS OPERATION
LOAD###%

Shortly after transfer into the UPS online (normal) mode, the UPS will automatically begin a battery test if the setting is enabled (see page 40). This test ensures a healthy battery system is available should it be necessary to support the load. During the test, the LCD reports the current battery voltage as a percent of its expected value at full charge. This figure will drop throughout the test, as the battery voltage is intentionally lowered to test performance. The test lasts for about 10 seconds, during which the following screen appears:

BATTERY TEST
BAT VOLTAGE ##%

Once the battery test has concluded, the LCD will return to display of the current UPS operation mode and percent load. It should appear as follows:

UPS OPERATION
LOAD ###%

Data Display Screens

The 'Data Display Screens' sequentially display the data parameters that can be monitored by operator. To enter the series of Data Display Screens, press "UP" or "DOWN" arrows while the current System Overview Screen is appearing.

NOTES

- 1 If the "SET/MONITOR" key is pressed from any of the Data Display Screens then the display will advance to the Data Setting Screens. (see page 36 the Data Settings Screens).
- 2 Displays L-N output voltages.
- 3 Displays the current as a % of maximum load capacity.
- 4 Displays the battery charge voltage as a % of the rated nominal DC voltage of the batteries.
- 5 If the "SHIFT/SELECT" key is pressed from any one of the Timer Start Data, Timer Stop Data, Weekly Schedule, Special Operate, and Special Off time screens then special 'Data Display Screens' are viewed. These functions can only to be changed by serial communication interface (see page 37).

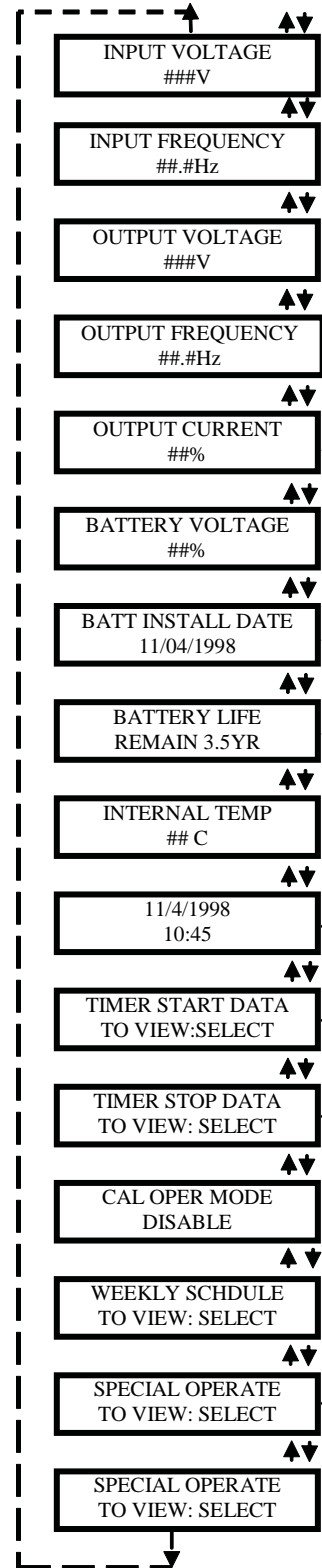

Special Display Screens

The special 'Data Display Screens' show below depict settings that can be viewed (but not changed locally) on the LCD panel. These settings can only be changed through the RS232C or optional RemotEye network card.

Continued from Timer Start Data Screen page 36

START TIME 1 DAY
##HR ##MIN ##SEC

Continued from Timer Stop Data Screen page 36

STOP TIME 1 DAY
##HR ##MIN ##SEC

Continued from Weekly Schedule Data Screen page 36

WEEKLY (MON)
(1) ###.## - ###.##

Continued from Special Operate Data Screen page 36

START 1:
###.## - ###.##

Continued from Special Off Time Data Screen page 36

STOP 1:
###.## - ###.##

NOTES

1 To access the data setting screens press the “**SET/MONITOR**” key from any of the (see page 38) Data Settings Screens.

2 Pressing the “**SHIFT/SELECT**” and “**CANCEL**” key returns to the Data Display Screens.

Data Setting Screens

The 'Data Setting Screens' sequentially display the data variables that can be set. Each variable is displayed as the "DOWN" arrow key is pressed. The "UP" arrow can also be pressed at any time to back up to the previous screen:

NOTES

- 1 When the automatic battery test mode has been set to YES then the this screen is displayed when scrolling through the 'Data Setting Screens'.

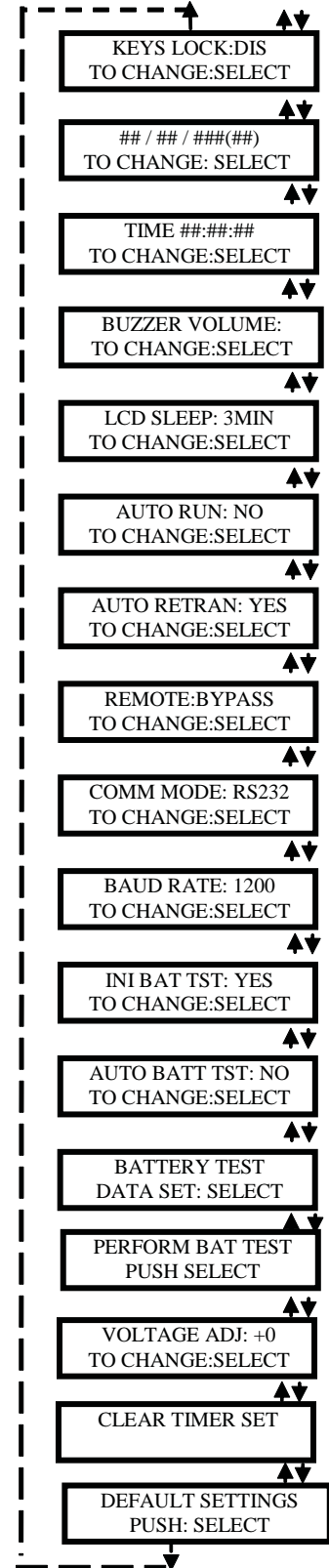

Data Setting Screens (Cont'd)

The following screens show the procedure for setting the data variables. They are accessed from the main 'Data Setting Screens' (see page 38) when the "SHIFT/SELECT" key is pressed:

The Keylock function allows the operator to disable the RUN + STOP button functions. When this function is set to EN the unit will remain in the operating mode it was in when enabled and will not be able to be changed with the RUN + STOP buttons until this function is disabled. With this function set to DIS, the RUN + STOP buttons function normally. The default setting is DIS.

2 = High
1 = Low
0 = Off
Default setting is 2 = High (loudest)

Displays the number of minutes (3 or 30) of idle time before the LCD will go blank (this is to prolong LCD life). The LCD will be active again once a display button is pressed. Default setting is 3 min.

If set to YES, the unit will automatically start up in the UPS mode (on line) when input voltage is applied, regardless of what mode it was in when shut down. Default setting is NO.

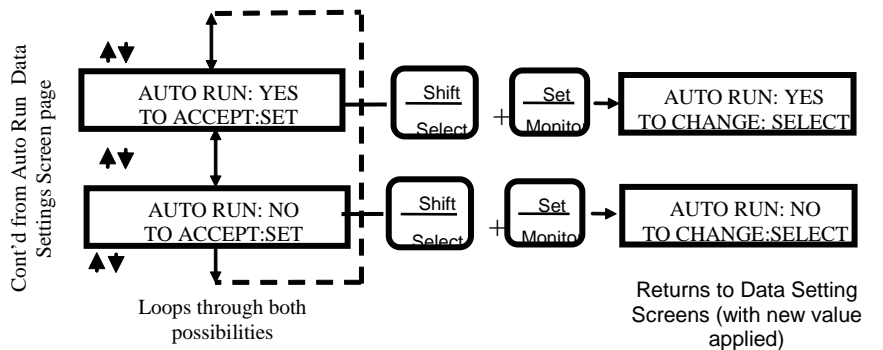
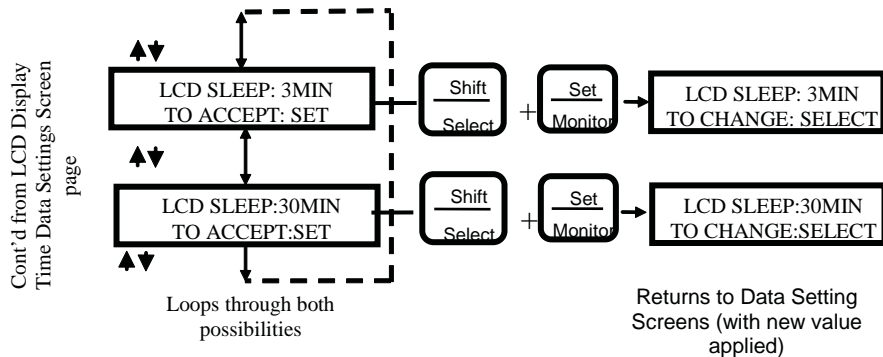
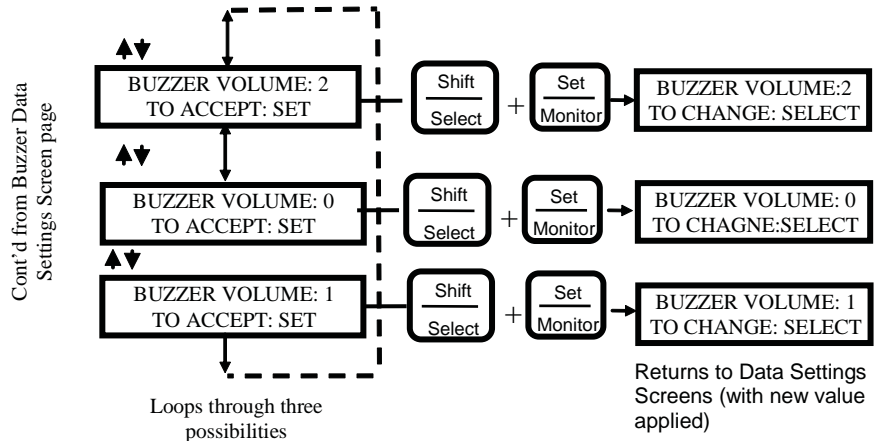
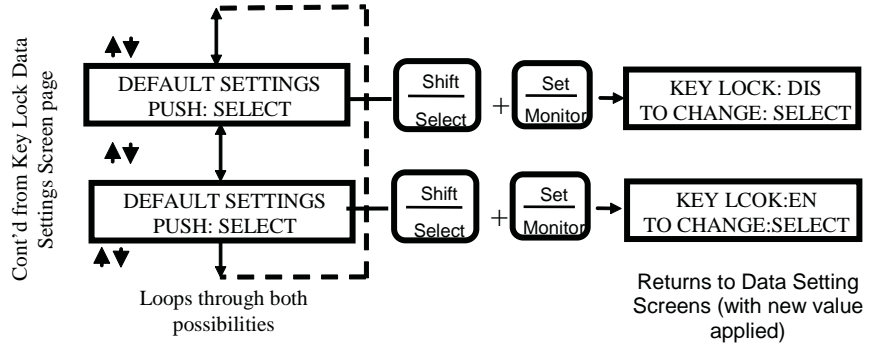

Data Setting Screens (Cont'd)

The following screens show the setting procedure for setting the data variables. They are accessed from the main 'Data Setting Screens' (see page 38) when the “SHIFT/SELECT” key is pressed:

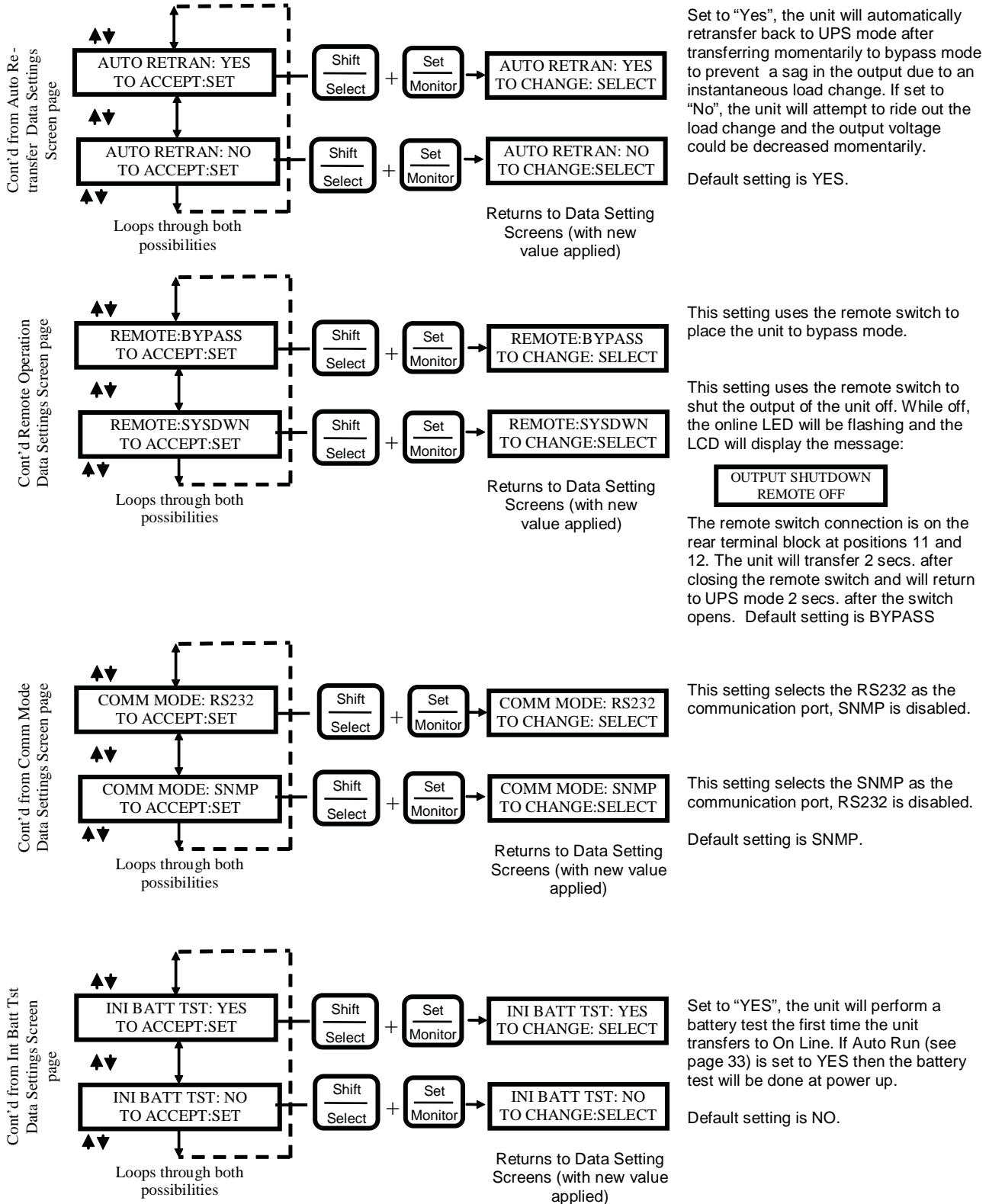

Data Setting Screens (Cont'd)

The following screens show the setting procedure for setting the data variables. They are accessed from the main 'Data Setting Screens' (see page 38) when the "SHIFT/SELECT" key is pressed:

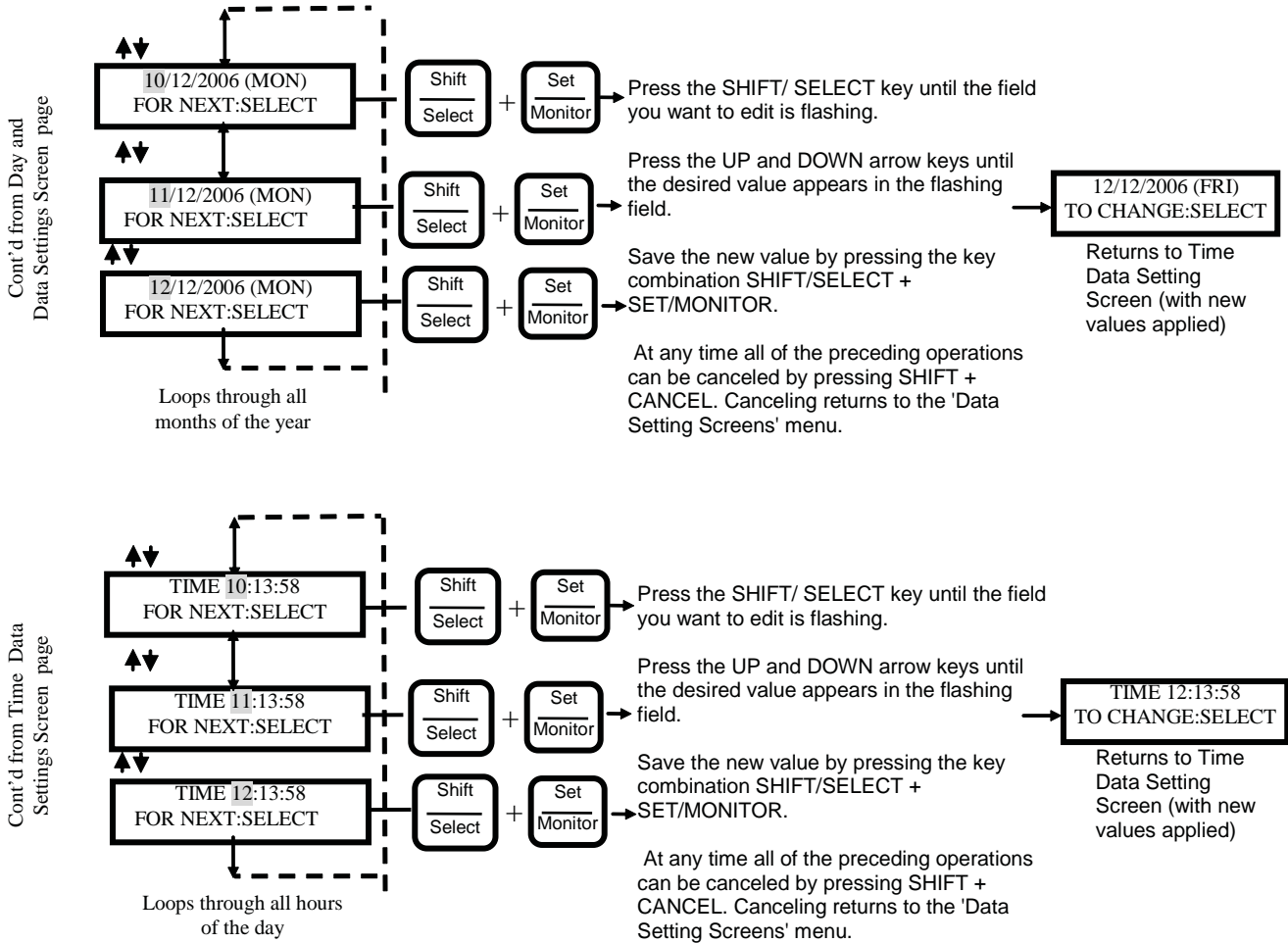

Data Setting Screens (Cont'd)

The following screens show the setting procedure for setting the data variables. They are accessed from the main 'Data Setting Screens' (see page 38) when the "SHIFT/SELECT" key is pressed:

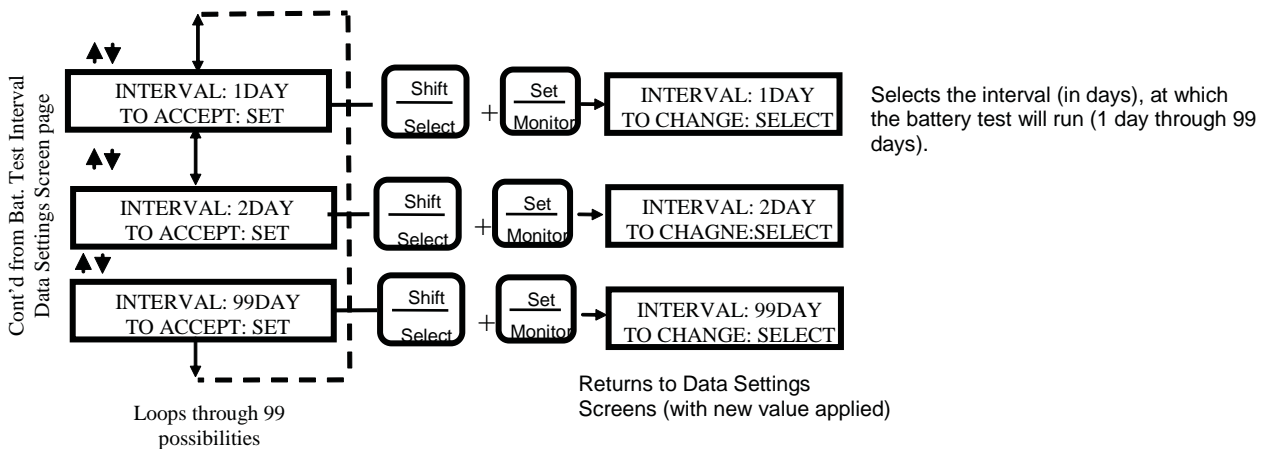
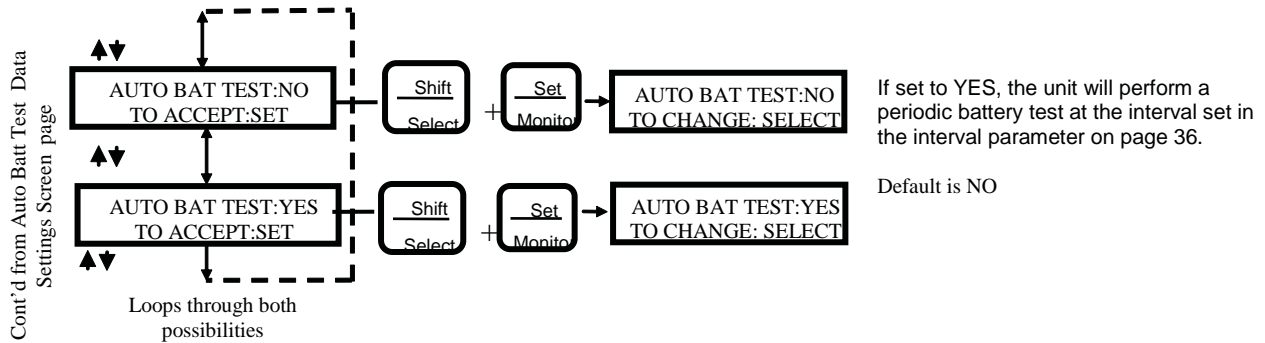
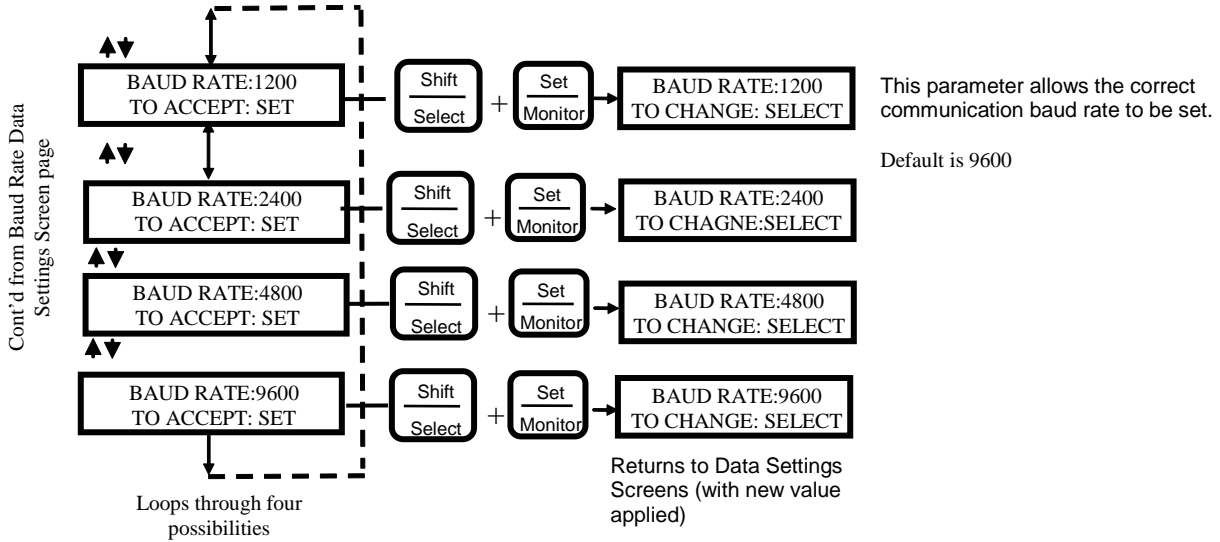

Data Setting Screens (Cont'd)

The following screens show the setting procedure for setting the data variables. They are accessed from the main 'Data Setting Screens' (see page 38) when the **SHIFT/SELECT** key is pressed:

Cont'd from Bat. Test Interval Data Setting Screen page

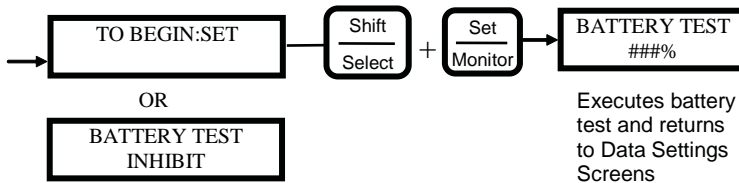

This parameter has no options to set. A battery test will be performed once the SHIFT + SET button is pressed.

Executes battery test and returns to Data Settings Screens

If the BAT TEST INHIBIT message is displayed, it indicated that a battery test has been performed recently. The UPS will not allow frequent battery tests to insure that the batteries remain in a fully charged state.

Cont'd from Voltage Adj Data Settings Screen page

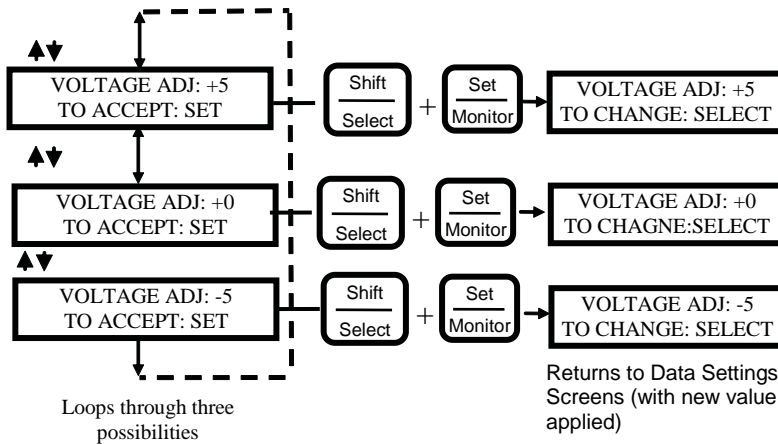

This parameter allows the user to offset the output voltage (while the unit is running on-line), by 1% increments between -5% to +5%.

Default value is +0

Returns to Data Settings Screens (with new value applied)

Cont'd from Clear Timer Data Setting Screen page

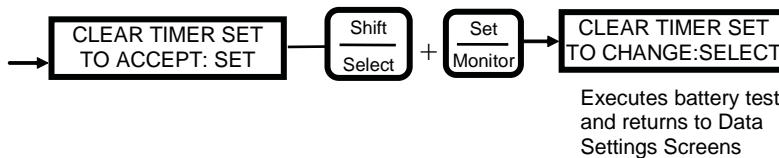

This parameter has no options to set. Pressing the SHIFT + SET button while this message is displayed will cancel timer setting.

Executes battery test and returns to Data Settings Screens



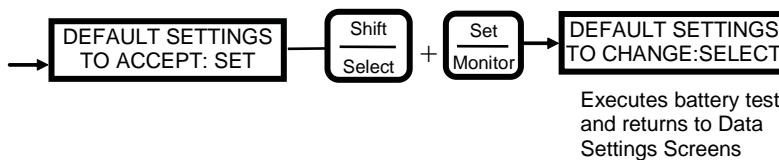











Cont'd from Default Settings Data Setting Screen page



Executes battery test and returns to Data Settings Screens

System Warning Messages

Warning messages will be displayed when an abnormal operating condition occurs. The following chart shows possible messages and their meaning.

LCD Message	LED Message	Meaning/Action
OVERLOAD: 132%	 Amber LED  Flashes Alarm	<p>Meaning: The UPS is overloaded (110% or above). Unit will switch to bypass operation or shut down if no action is taken.</p> <p>Action: Shut down excess equipment to reduce load</p>
OL: REDUCE LOAD	 Amber LED  Flashes Alarm	<p>Meaning: The UPS is overloaded (110% or above) and has switched to bypass. Unit will shut down the output if no action is taken.</p> <p>Action: Shut down excess equipment to reduce load</p>
BATTERY LOW 87%	 Amber LED  Flashes Alarm	<p>Meaning: The battery level has dropped low (about 90% or less) during operation. Continued operation in this mode will deplete battery and cause output shut down.</p> <p>Action: Immediately shut down the load equipment in an orderly fashion and then press the STOP key.</p>
UPS-TEMP 52°C	 Amber LED  Flashes Alarm	<p>Meaning: The unit is overheated (warning is given when the internal temperature reaches and exceeds 50° C rise @ 40° C ambient).</p> <p>Action: Check to see if the ambient temperature is abnormally high (40° C or more). If so, turn on air conditioning. Also, check ventilation fan at the back of the unit for operation or obstructions. Otherwise, shut down the unit and call for service.</p>
REPLACE BAT SOON	 Amber LED  Flashes Alarm	<p>Meaning: Advance notice that batteries are nearing the end of the expected lifetime.</p> <p>Action: Contact your Toshiba authorized service center to arrange for battery replacement.</p>
REPLACE BATTS	 Amber LED  Flashes Alarm	<p>Meaning: Batteries at end of life.</p> <p>Action: Have batteries replaced immediately.</p>
REQUIRES SERVICE PLEASE SERVICE	 Amber LED  Flashes Alarm	<p>Meaning: Inspection of unit is advised.</p> <p>Action: Have inspection/service performed.</p>







System Fault Messages

When an abnormal operating condition occurs the following fault message will be displayed

FAULT (BYP OPER)
OUT-OV DC-OV >

If the input voltage is normal when the fault occurs then the UPS will switch immediately to the bypass mode to continuously feed power to the load. If the input power is abnormal while in the bypass mode the UPS will shut down the output to prevent load equipment damage.

Press **CANCEL** or **RESET** keys to view the messages explaining the system fault (the ">" indicates other faults:

LCD Message	LED Message	Meaning/Action
DC-OC	 Red LED On-Line/ Fault Flashes	Meaning: DC overcurrent condition occurred. Action: UPS is probably faulty. Check the UPS operating conditions at time of fault. Not advisable to try restarting. Call for service.
OUT-OV	 Red LED On-Line/ Fault Flashes	Meaning: Output overvoltage condition occurred. Action: UPS is probably faulty. Check the UPS operating conditions at time of fault. Not advisable to try restarting. Call for service.
OUT-UV	 Red LED On-Line/ Fault Flashes	Meaning: Output undervoltage condition occurred. Action: UPS is probably faulty. Check the UPS operating conditions at time of fault. Not advisable to try restarting. Call for service.
DC-OV	 Red LED On-Line/ Fault Flashes	Meaning: DC overvoltage condition occurred. Action: UPS is possible faulty, input wiring error, input overvoltage or connection of a motor load. Try restarting. If condition persists call for service.
OVERLOAD	 Red LED On-Line/ Fault Flashes	Meaning: Output overload condition occurred. Action: Reduce equipment load to 100% or less and try restarting.
DC-UNBALANCE	 Red LED On-Line/ Fault Flashes	Meaning: DC voltage unbalance occurred. Action: Possible causes are UPS fault or connection of half-wave rectifier load. Check load and try restarting. If condition persists, call for service.
OVERHEAT	 Red LED On-Line/ Fault Flashes	Meaning: Overheating condition occurred. Action: Check unit for blocked or in-operable fan. Lower ambient temperature if 40° C or greater. Bypass operation will also cease if overheat condition is not corrected within 1 hr. from inverter shutdown. Try restarting and if condition re-occurs plan for total shutdown and call for service.

Status Change Indications

Warning messages will be displayed when an abnormal operating condition occurs. The following chart shows possible messages.

LCD Message	Meaning/Action
AUTO RETRANSFER	<p>Meaning: The UPS has automatically entered the bypass mode because it detected an output current that is larger than the inverter can normally handle.</p> <p>Action: Remove excess load equipment to reduce the output current.</p>
AUTO RETRANSFER	<p>Meaning: The UPS input frequency is outside of the ± 1 Hz synchronization frequency tolerance of the inverter output frequency.</p> <p>Action: No action is necessary. Unit cannot switch to bypass mode while the input frequency is out of tolerance with the output frequency.</p>
BATTERY LOW	<p>Meaning: The battery level has dropped low (about 90% or less) during operation. Continued operation in this mode will deplete battery and cause output shut down.</p> <p>Action: Immediately shutdown the load equipment in an orderly fashion and then press the STOP key.</p>
TIME TO RUN 4 MIN	<p>Meaning: A start notice is displayed 5 minutes before starting the UPS when the start timer is set by communication., and continues to display remaining time during countdown.</p> <p>Action: None required</p>
TIME TO STOP 10 SEC	<p>Meaning: A stop notice is displayed 5 minutes before stopping the UPS when the stop timer is set by communication.</p> <p>Action: None required.</p>
KEY LOCK:EN	<p>Meaning: When the key lock is set or the timer is set to start/stop the UPS by data communication, pressing the RUN or STOP key displays this message.</p> <p>Action: None required.</p>

UPS Protection System

System Protection Features

The following schematic shows the electrical locations of the protection devices on the 1600EP models.

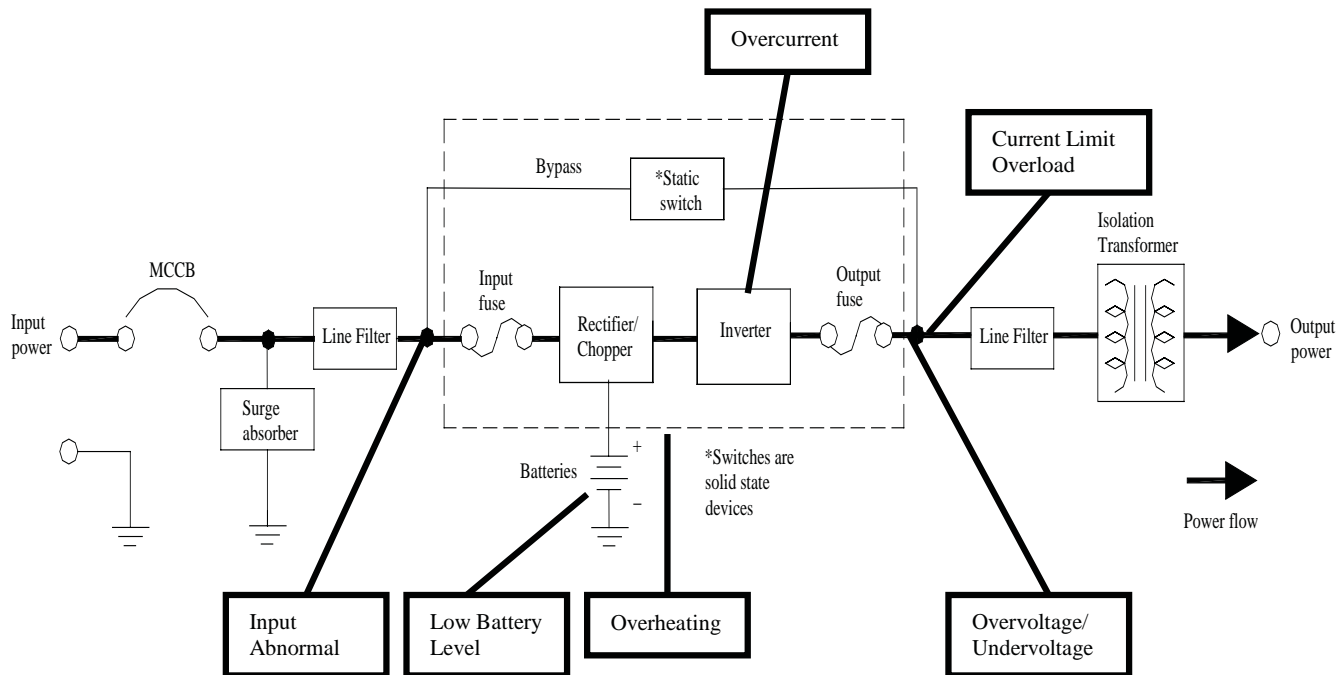

System Protection Functions

The following charts show the built-in UPS system fault protection functions on all the 1600EP models.

BUILT-IN UPS FAULT PROTECTION FUNCTIONS

Protection Item	Output Overvoltage	Output Undervoltage	Output Overload
LCD Message	OUT-OV	OUT-UV	OVERLOAD
Cause	Control malfunction; chip error	Control malfunction; wire disconnected	Overload; Short circuit at load
Operation Mode After Fault	Bypass operation; Chopper and inverter are stopped.		Inverter OL: Transfer to bypass; Bypass OL: inverter, chopper
Audible Alarm	Yes; continuous buzzer		see 'Audible Alarm Functions' on page 31
Visible Alarm	Red Fault LED "ON"		Inverter OL: no fault lamp Bypass OL: fault lamp "on"
Relay Contact Alarm	Fault relay closed; Bypass relay closed		Fault relay open; Inverter OL: Bypass relay closed Bypass OL: Bypass relay open
Auto-retransfer	No		Inverter OL: Yes if bypass is OK Bypass OL: No

BUILT-IN UPS FAULT PROTECTION FUNCTIONS (CONT'D)

Protection Item	Internal Overheat	DC Circuit Overvoltage	DC Circuit Overcurrent
LCD Message	DC UNBALANCE	DC-OV	DC-OC
Cause	Fan failure; High ambient temperature	Chopper malfunction	Inverter/chopper fault
Operation Mode After Fault	Shutdown; no output	Bypass operation; Chopper and inverter are stopped Inverter OL: Transfer to bypass;	
Audible Alarm	Yes; continuous buzzer	Yes; continuous buzzer	
Visible Alarm	Red Fault LED "on"	Red Fault LED "on"	
Relay Contact Alarm	Fault relay closed; Bypass relay closed		
Auto-retransfer	No		

Preventive Maintenance/Parts Replacement

Preventive Maintenance

Toshiba's 1600EP Series of uninterruptible power systems have been designed to provide years of trouble-free operation requiring a minimum of preventive maintenance.

The best preventive measure that the UPS user can take is to keep the area around the unit, particularly the air inlet vents, clean and free of moisture and dust accumulations. If the atmosphere of the installation site is very dusty, use a vacuum cleaner to periodically remove dust accumulations around and from the unit.



CAUTION

Only a qualified Toshiba Representative should be allowed to perform any routine maintenance or service on this equipment other than those preventive maintenance details which are described directly above this caution.

Parts Replacement

The following list shows recommended intervals for periodic replacement of certain UPS parts:

- 1 Batteries: In order to maintain system reliability, the UPS batteries should be replaced on a regular schedule. To ensure reliable operation, all of the batteries should be replaced at the same time. Use the following chart for replacement:

UPS BATTERY REPLACEMENT

BATT AMB TEMP	AVERAGE LIFETIME	(% REDUCED)
20-25° C (68-77°F)	Approximately 5 yrs	0%
30° C (86°F)	Approximately 3.5 yrs	30%
35° C (95°F)	Approximately 2.5 yrs	50%
40° C (104°F)	Approximately 1.8 yrs	66%
45° C (113°F)	Approximately 1.25 yrs	75%

- 2 Aluminum electrolytic capacitors: Replace once every 5 years.
- 3 Fuses: Replace once every 7 years.
- 4 Cooling fan: When operated in an ambient temperature of 30° C (86°F) to 40° C (104°F), replace every 3.5 years. When operated in an ambient temperature of less than 30° C (86°F), replace every 5 years.

Optional Receptacle Panel Installation Instructions

These are the instructions for installing the optional Modular Output Receptacle Panels for the 1600EP Series UPS. These instructions apply to all UE3-RP-XX panel options.

WARNING: The work outlined in these instructions is to be performed only on a completely un-energized UPS system.

Please refer to Figure 1 for location of UPS referenced material. Refer to Figure 2 for material referring to the receptacle panel module.

Step 1: Remove modular receptacle panel cover plate

On the rear of the UPS, locate the cover plate for the receptacle panel module interface (see Figure 1).

Remove the 6 mounting screws.

Remove the cover plate. A square-shaped “plug” will appear exposed near the upper-left corner of the uncovered slot.

Step 2: Snap-In Output Receptacle modular panel

Carefully mate the square-shaped connector on the UPS to its matching counter part on the rear of the modular panel.

Step 3: Mount the receptacle panel

Attach the screws removed from the cover plate through the mounting holes of the receptacle panels and back into the UPS mounting points.

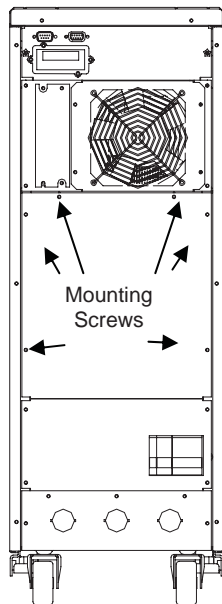

Figure 1

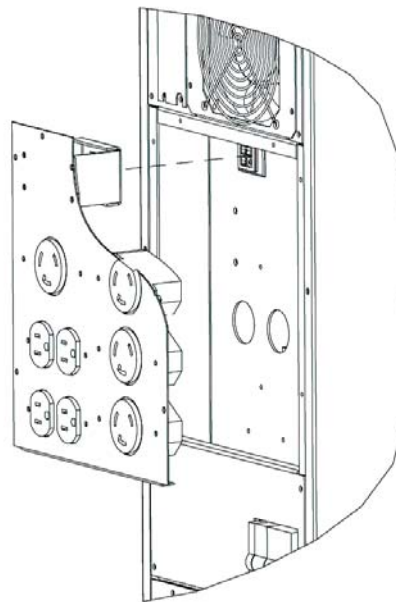

Figure 2

External Layouts/Dimensions/Shipping Weights

Dimensional Data

DIMENSIONAL DATA							
	3.6kVA	6kVA	8kVA	10kVA	14kVA	18kVA	22kVA
A	27.5 in (699 mm)	27.5 in (699 mm)	28.4 in (699 mm)	28.4 in (699 mm)	39.1 in (992 mm)	39.1 in (992 mm)	39.1 in (992 mm)
B	10 in (254 mm)	10 in (254 mm)	13 in (254 mm)	13 in (254 mm)	17.5 in (445 mm)	17.5 in (445 mm)	17.5 in (445 mm)
C	33 in (838 mm)	33 in (838 mm)	33.5 in (838 mm)	33.5 in (838 mm)	34.8 in (885 mm)	34.8 in (885 mm)	34.8 in (885 mm)
D	24.7 in (627 mm)	24.7 in (627 mm)	25.7 in (627 mm)	25.7 in (627 mm)	35.6 in (904 mm)	35.6 in (904 mm)	35.6 in (904 mm)
E	2.8 in (72 mm)	2.8 in (72 mm)	2.7 in (72 mm)	2.7 in (72 mm)	3.47 in (88 mm)	3.47 in (88 mm)	3.47 in (88 mm)

Shipping Weights

SHIPPING WEIGHTS

Model	Pounds	Kilograms
3.6kVA	365	166
6kVA	385	175
8kVA	490	222
10kVA	490	222
14kVA	620	281
18kVA	750	340
22kVA	750	340

External Layouts *

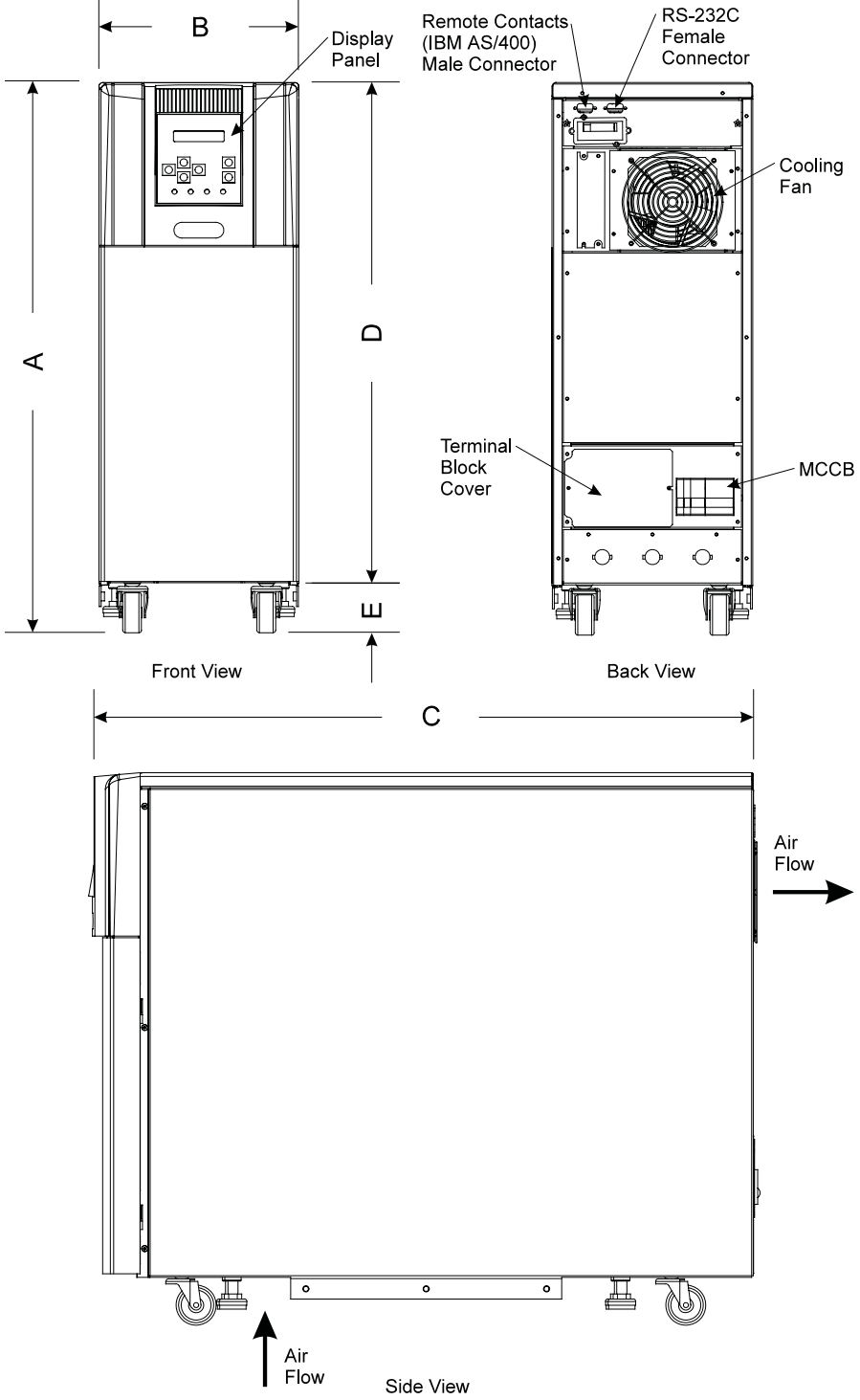

External Layouts * (cont'd)

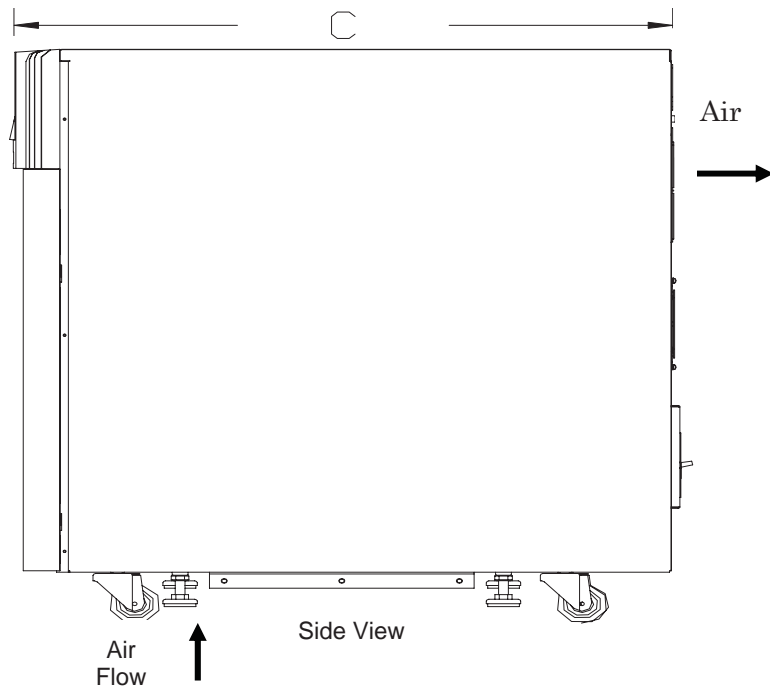
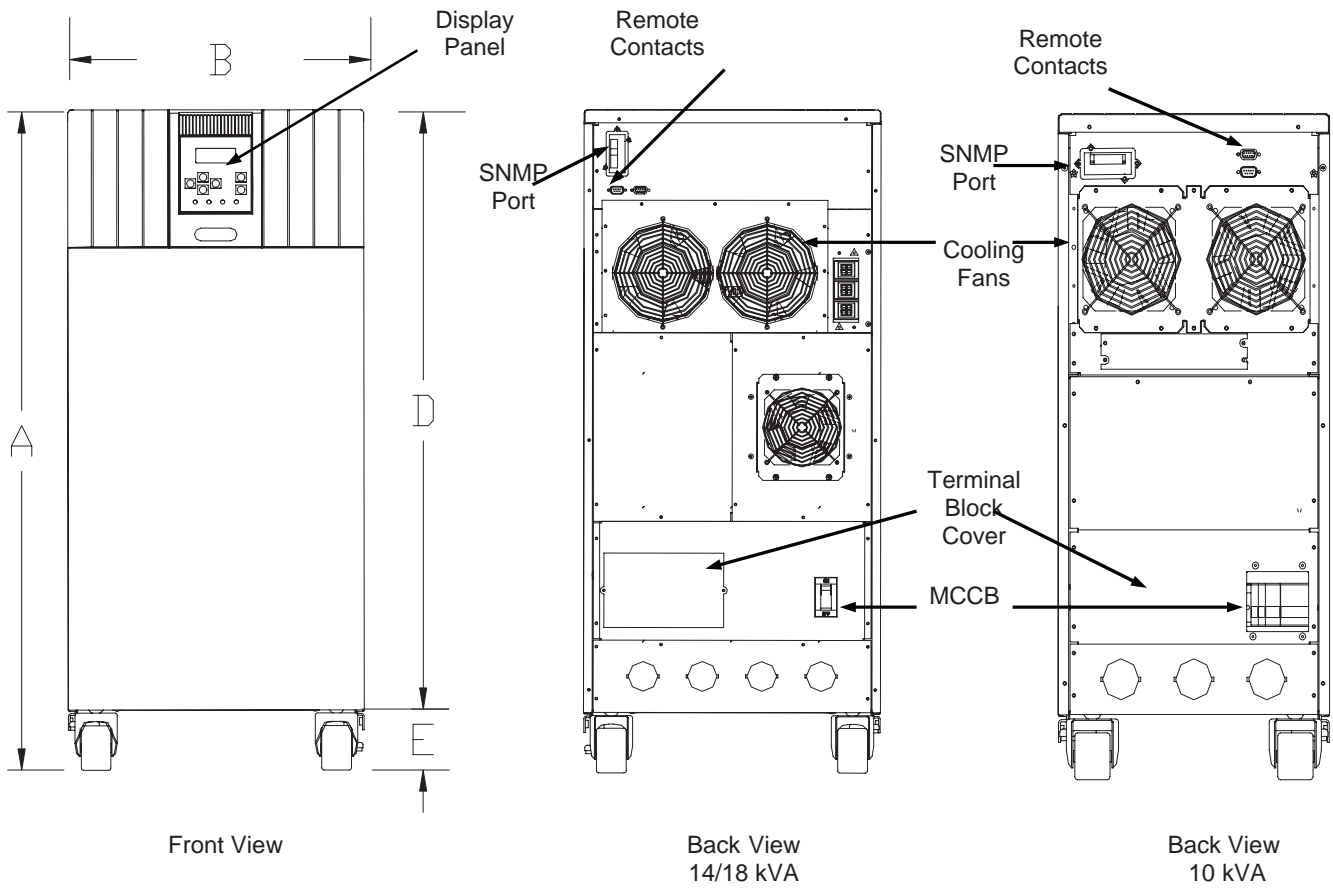

Index

A

- AC input mode 29, 30
- Acoustical noise 21
- Altitude 21, 24
- Application 12
- Audible alarm 12, 32, 47, 48
 - functions 31
- Automatic Retransfer 21, 24

B

- Backup mode 30
- Battery
 - backup mode 30, 31
 - backup time 20, 22, 23, 26, 30
 - lifetime 21, 24
 - low-voltage tolerances 26
 - manufacturer 22, 25
 - pack 22, 25
 - Pack (quantity) 22, 25
 - recharge tolerances 28
 - recharging 28
 - replacement 10, 21, 24, 44, 49
 - voltage drop 12, 17, 30
- Buzzer volume 21, 24
- Bypass
 - disable 21, 24
 - mode 27, 29, 33, 34
 - overload capacity 20, 23
 - switch 21, 24

C

- capacitors 49

- Common-mode noise 12, 20, 23
- Communication interface 17
- Cooling fan 49

D

- Data. *See* Data Display Screens, Data Setting Screens
- Data Display Screens 33, 34–37
- Data Setting Screens 33, 36, 38–43
- DB9 Connector
 - female pinouts 19
 - male pinouts 17
- Dimensional Data 51
- Disposal 13

E

- Emergency Power Off (EPO) function 15, 16, 30, 34
- Enclosure 22, 25
- Environment 13, 21, 24
- Event Data Storage 21, 24

F

- fan 22, 25, 44, 48
- Fault 21, 24
 - protection functions 47, 48
 - signal 17, 29, 31
- Frequency
 - AUTO/MAN 20, 23
 - input 20, 23
 - output 20, 23
 - synchronization 46
 - Warning 15, 46
- Front Panel layout 32

G

ground

Importance of, 14

RS-232C 19

terminals 16

Grounding 14

H

Humidity 24

humidity 13, 14

Operating environment 21

I

Input Capacity 20, 23

Input Frequency 20, 23

warning 15, 46

Input Mode, AC 29

Input Voltage 20, 22, 23, 25

requirements 15

Inspection 13, 44

Installation Precautions 14

Interface

communications 17, 18, 19

receptacle panel module 50

RS232 ASCII 21, 24, 36

user 21, 24

Inverter Overload Capacity 20, 23

K

Keys 21, 24, 32, 33

L

LED (Light Emitting Diode) displays 32

Lifetime

battery 21, 24, 49

battery warning light 44

capacitors, Aluminum electrolytic 49

fan, cooling 49

fuses 49

Liquid Crystal Display (LCD) Functions 32

Low Voltage Tolerance 26

M

maximum ambient operating temperature 10

Mode

AC Input 29

Battery Backup 30

display 32, 33, 34

Static Bypass 29

test 38

monitoring. *See* Data Display Screens

N

Normal input power system 17

O

Operation modes. *See* Modes

output disconnect 10

Overload Capacity 20, 23

Overvoltage

DC 48

input 33

output 45, 47

P

Peak Output Current 20, 23

Power Backup 12

Power Conditioning 12

Power factor

input 20, 23

output, rated load 20, 23, 26
Power failure signal 17, 18
Precautions 14, 15
Preventive Maintenance 49
Protection System 47

R

Real Time Clock 21, 24
Receptacle Panels 50
Recharge Time 20, 23, 28
relay switch 17
remote contacts interface 17
Remote Switch 16
RemotEye Network Card 19
Restrictions on UPS use 15
RS-232C 19

S

Safety instructions 8, 10
Schedule Operation 21, 24
Shipping Weight 51
Shutdown voltage 26
Signal Function
 RS-232C 17
Signal Words 9
Size
 battery packs 22, 25
 UPS dimensions 22, 25
 wire 16
Specifications 20
Start-Up Screens 34
Starting the UPS 27
Status Change Indications 46
Stopping the UPS 27, 46
Stop Signal Operation 18

Storage 13, 21, 24
 temperature 13, 21, 24
synchronization frequency tolerance 46
System Fault Messages 45
System Warning Messages 44

T

Terminal Block 16
Theory of operation 12
torque, tightening 16

U

Unpacking 13
UPS
 Discharge Process 26, 30
UPS Connections 16
UPS functional overview 12
UPS stop signal input 17, 18

V

ventilation 14, 15
Voltage Transient 20, 23
Volume, Buzzer. *See* Buzzer Volume

W

Warranty 3, 4, 13

TOSHIBA

TOSHIBA INTERNATIONAL CORPORATION

INDUSTRIAL DIVISION

13131 West Little York Road, Houston, Texas 77041

Tel 713/466-0277 Fax 713/466-8773

US 800/231-1412 Canada 800/872-2192 Mexico 01/800/527-1204

Copyright 1/2007
Printed in the U.S.A.